

For the electronic measurement of current: DC, AC, pulsed..., with galvanic separation between the primary and the secondary circuit.

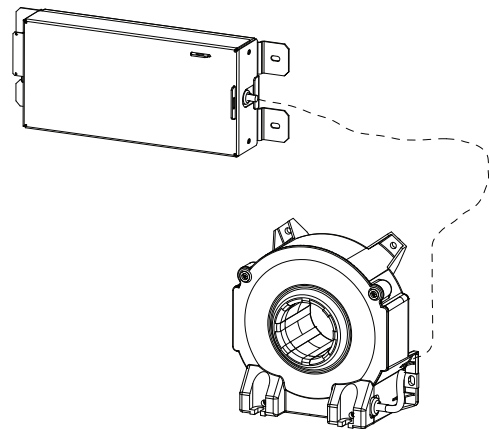

RoHS



Features

- Bipolar and insulated current measurement up to 3 kA
- Current output
- Aperture for primary cable or bus bar and secondary connections on 15-pin D-Sub
- Other options possible for secondary connections.

Special feature

- Cable length
Measuring head / electronic: 1 m.

Advantages

- Exceptional accuracy (better than Class 0.5R)
- Low consumption and losses
- Good behavior under common mode variations
- High bandwidth
- Very low temperature drift
- High immunity to external interference.

Applications

- Energy metering
- Propulsion converter
- Substations
- Test and measurement.

Standards

- EN 50155: 2007
- EN 50124-1: 2001
- EN 50121-3-2: 2006
- EN 50463: 2012.

Application Domains

- Traction (fixed and onboard)
- Industrial.

Absolute maximum ratings

Parameter	Symbol	Value
Maximum supply voltage ($I_p = 0$ A, 0.1 s)	$\pm U_C$	± 34 V
Maximum supply voltage (working) (-40 .. 85 °C)	$\pm U_C$	± 26.4 V
Maximum primary current	I_P	100 kA
Maximum steady state primary current (-40 .. 85 °C)	I_{PN}	2000 A
Maximum steady state test winding current (-40 .. 85 °C)	I_T	1 A
Maximum /VALID output current		0.1 A
Maximum /VALID output voltage		same limits as supply voltage

Absolute maximum ratings apply at 25 °C unless otherwise noted.

Stresses above these ratings may cause permanent damage. Exposure to absolute maximum ratings for extended periods may degrade reliability.

Insulation coordination

Parameter	Symbol	Unit	Value	Comment
Rms voltage for AC insulation test, 50 Hz, 1 min	U_d	kV	14	100 % tested in production
Impulse withstand voltage (1.2/50 μ s exponential shape)	\dot{U}_W	kV	30	
Partial discharge extinction rms voltage @ 10 pC	U_e	V	5000	bar with centered
Insulation resistance	R_{IS}	M Ω	200	measured at 500 V DC
Clearance (pri. - sec.)	d_{Cl}	mm	See dimensions drawing on page 11	Shortest distance through air
Creepage distance (pri. - sec.)	d_{Cp}	mm		Shortest path along device body
Case material	-	-	V0 according to UL 94	
Comparative tracking index	CTI		600	

Environmental and mechanical characteristics

Parameter	Symbol	Unit	Min	Typ	Max
Ambient operating temperature	T_A	°C	-40		85
Ambient storage temperature	T_S	°C	-50		90
Primary conductor temperature	T_B	°C			100
Mass	m	kg		5	

Class accuracy

Parameter	Accuracy class	Comment
Class accuracy for a rated primary current $I_{PN} = 2000$ A	0.5R	according EN 50463-2
Class accuracy for a rated primary current $I_{PN} = 1500$ A	0.5R	according EN 50463-2
Class accuracy for a rated primary current $I_{PN} = 1000$ A	0.5R	according EN 50463-2
Class accuracy for a rated primary current $I_{PN} = 750$ A	0.5R	according EN 50463-2
Class accuracy for a rated primary current $I_{PN} = 500$ A	0.5R	according EN 50463-2

If used for energy measurement according to EN 50463, please note that the re-verification period of the transducer may be subject to national or international legal requirements.

Recommended re-verification period is at least 8 years.

Electrical data

At $T_A = 25\text{ °C}$, $\pm U_C = \pm 24\text{ V}$, $R_M = 0.1\ \Omega$, unless otherwise noted.

Lines with a * in the conditions column apply over the $-40 \dots 85\text{ °C}$ ambient temperature range.

Parameter	Symbol	Unit	Min	Typ	Max	Conditions
Primary nominal rms current	I_{PN}	A			2000	*
Primary current, measuring range	I_{PM}	A	-3000		3000	*
Measuring resistance	R_M	Ω	0		2	* For $ I_{PM} < 3\text{ kA}$, max value of R_M is given in figure1
Secondary nominal rms current	I_{SN}	A		0.8		*
Secondary current	I_S	A	-1.2		1.2	*
Supply voltage	$\pm U_C$	V	± 21.6	± 24	± 26.4	*
Rise time of U_C (10-90 %)	t_{rise}	ms			100	*
Current consumption	I_C	mA	45	54	70	$I_P = 0\text{ A}$, $\pm U_C = \pm 24\text{ V}$, valid for + and - supplies
Offset current, referred to primary	I_O	A	-0.01	0.004	0.01	23 °C; 100 % tested in production
Magnetic offset current, referred to primary	I_{OM}	A		0.005		After $I_P = 10\text{ kA}$
Temperature variation of I_O , referred to primary	I_{OT}	A	-0.05	-0.01	0.05	-40 .. 85 °C; 100 % tested in production
Sensitivity	G	mA/A		0.4		
Sensitivity error	ε_G	%	-0.005	-0.0002	0.005	
Thermal drift of sensitivity	ε_{GT}	%	-0.01	0.002	0.01	* -40 .. 85 °C
Linearity error	ε_L	% of I_{PM}	-0.01	0.0004	0.01	* $\pm I_{PM}$ range
Overall accuracy at I_{PN}	X_G	% of I_{PN}	-0.01 -0.01	-0.0015 -0.0015	0.01 0.01	* 23 °C; 100 % tested in production -40 .. 85 °C
Overall accuracy at 10 % of I_{PN}		% of reading	-0.1	-0.0040	0.1	23 °C; 100 % tested in production
Overall accuracy at 5 % of I_{PN}		% of reading	-0.2	-0.015	0.2	23 °C; 100 % tested in production
Overall accuracy at 1 % of I_{PN}		% of reading	-1	-0.03	1	23 °C; 100 % tested in production
Overall accuracy at 0.4 % of I_{PN}		% of reading	-2.5	-0.3	2.5	23 °C
Output rms noise current, referred to primary	I_{no}	A		2		1 Hz to 1 MHz
Reaction time to 10 % of I_{PN}	t_{ra}	μs		0.1		0 to 2 kA, 100 A/ μs
Step response time to 90 % of I_{PN}	t_r	μs		0.1		0 to 2 kA, 100 A/ μs
Frequency bandwidth	BW	kHz		27 23 3		3 dB, 100 A 1 dB, 100 A 0.1 dB, 100 A
Start-up time	t_{start}	ms		400	500	*
Number of secondary turns	N_S			2500		
Number of turns (test winding)	N_T			200		

Typical performance characteristics

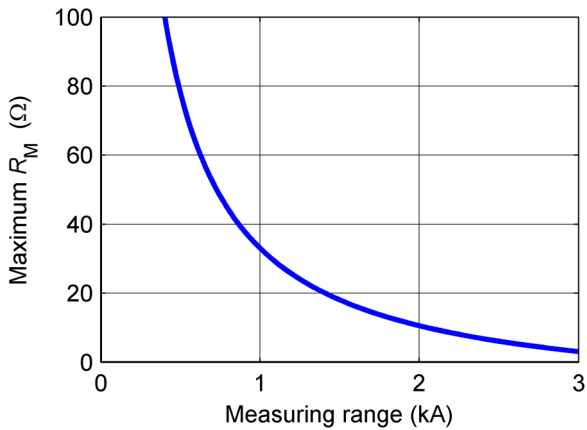

Figure 1: Maximum measuring resistance ($T_A = -40 \dots 85 \text{ }^\circ\text{C}$)

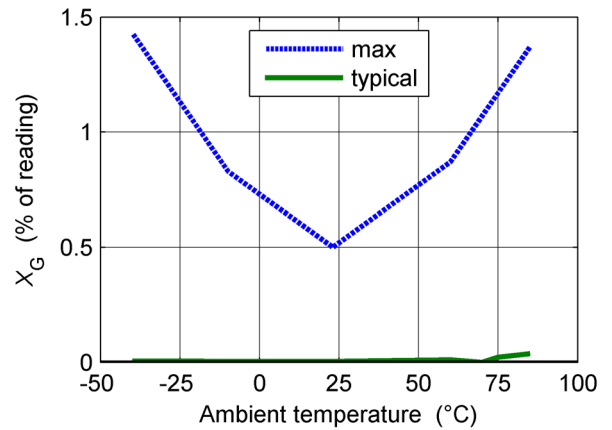

Figure 2: Overall accuracy in temperature for $0.1 I_{PN} \leq I_P \leq 1.2 I_{PN}$

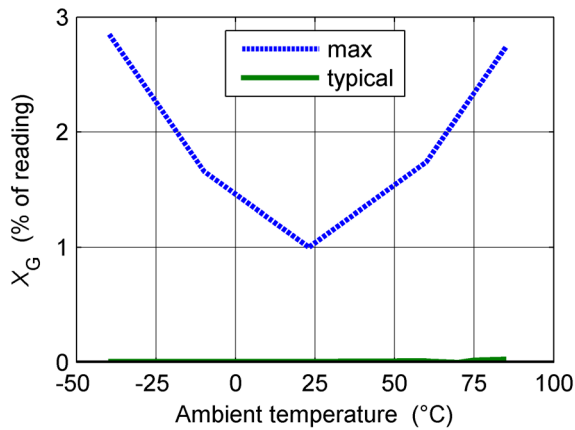

Figure 3: Overall accuracy in temperature for $0.05 I_{PN} \leq I_P < 0.1 I_{PN}$

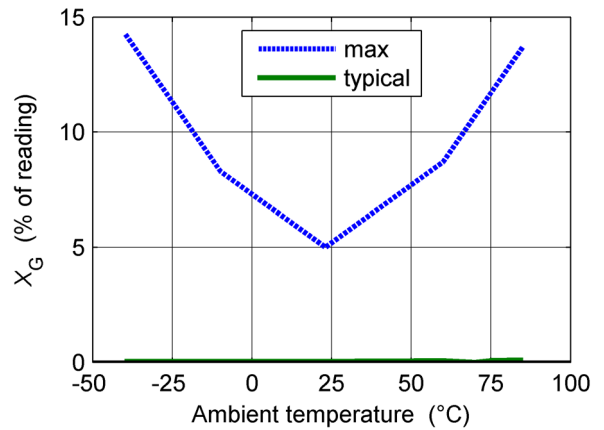

Figure 4: Overall accuracy in temperature for $0.01 I_{PN} \leq I_P < 0.05 I_{PN}$

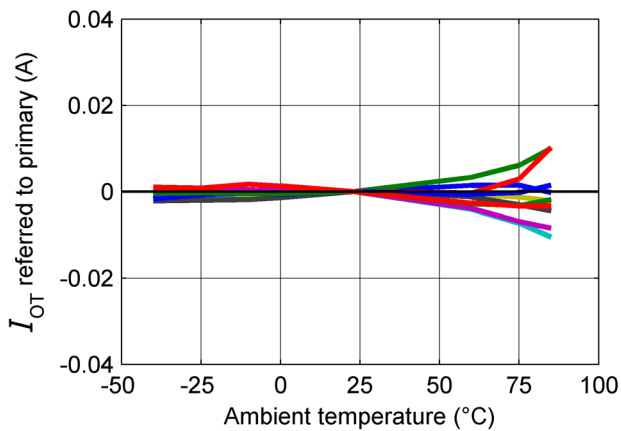

Figure 5: Typical offset variation in temperature (10 samples shown)

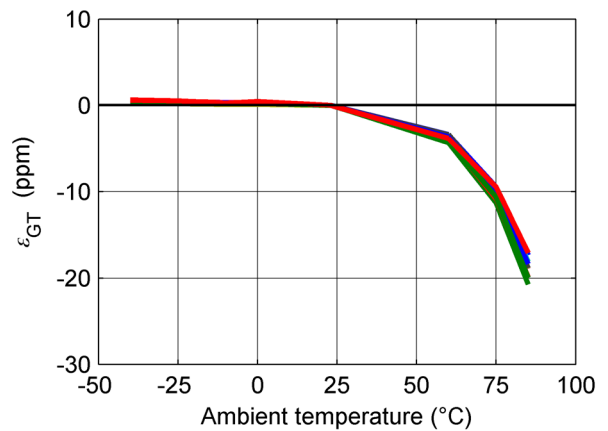

Figure 6: Typical sensitivity variation in temperature (10 samples shown)

Typical performance characteristics

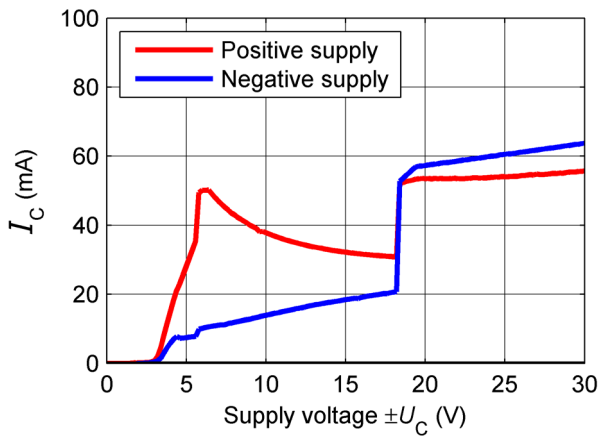

Figure 7: Typical supply current function of supply voltage ($I_p = 0 A$)

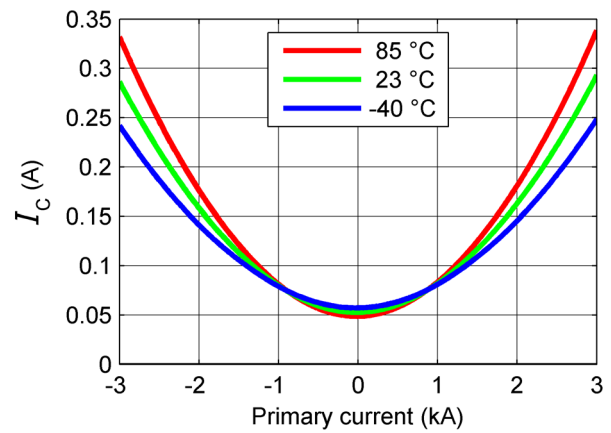

Figure 8: Typical supply current function of primary current ($R_M = 0.1 \Omega$, $\pm U_C = \pm 24 V$) (both supply currents are identical)

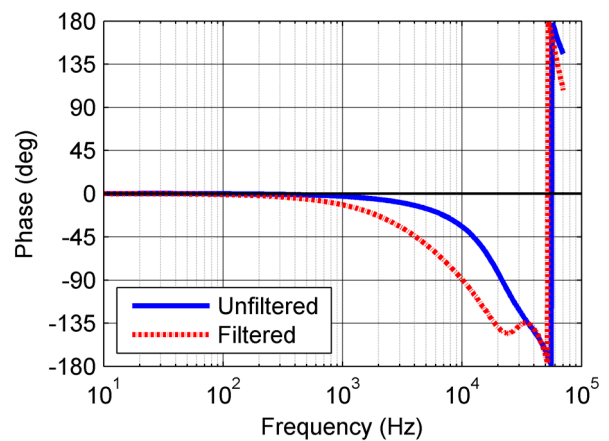
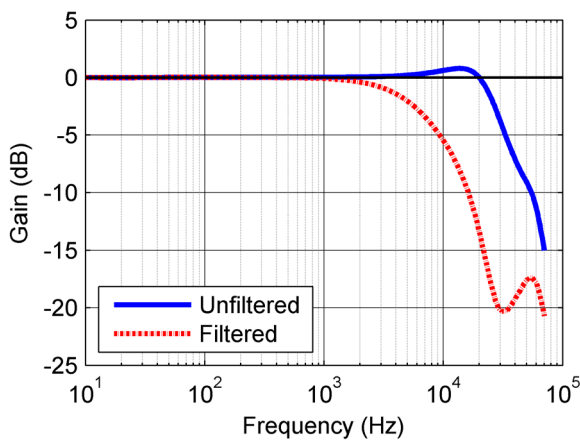

Figure 9: Typical frequency response, $I_p = 100 A rms$
Filtered output was measured with a 10 kHz 1st order low pass filter

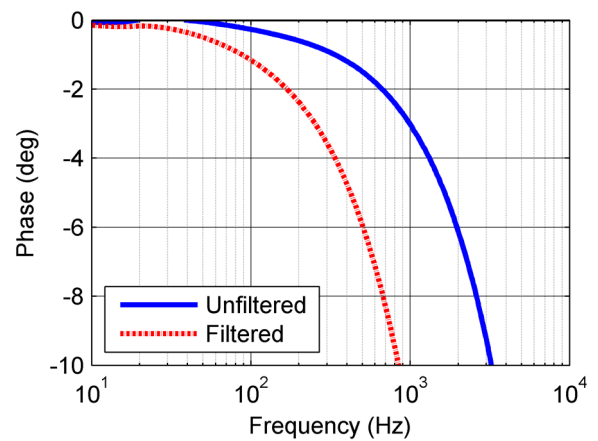
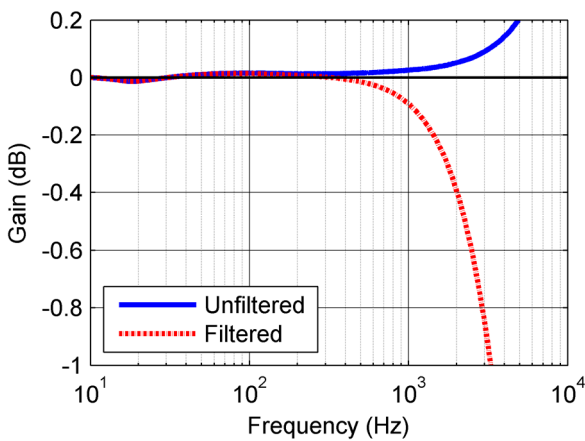

Figure 10: Typical frequency response (detail), $I_p = 100 A rms$
Filtered output was measured with a 10 kHz 1st order low pass filter

Typical performance characteristics

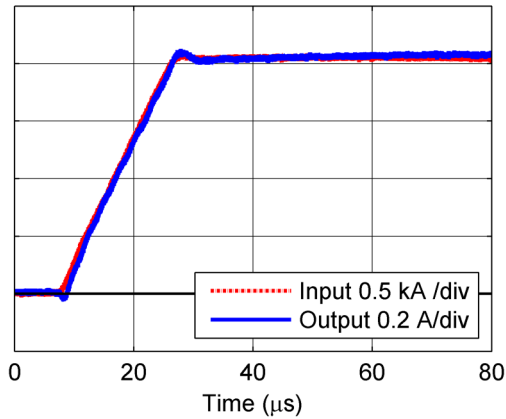

Figure 11: Typical step response (0 to 2 kA, 100 A/μs)

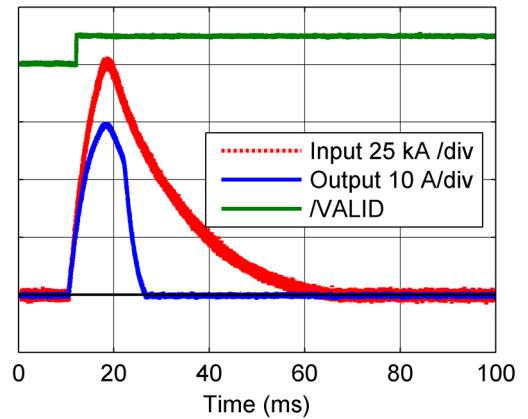

Figure 12: 100 kA overload behaviour

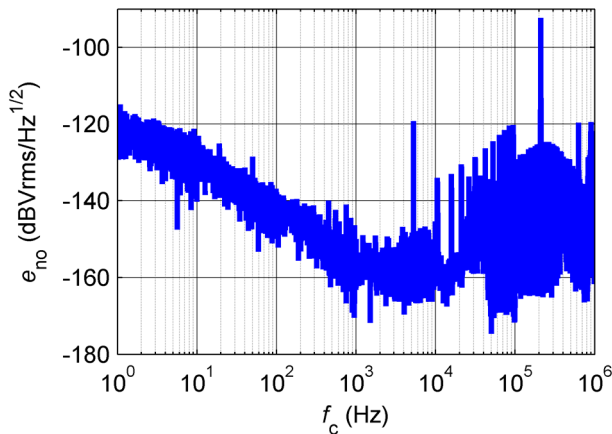

Figure 13: Typical noise voltage density e_{no} with $R_M = 1 \Omega$

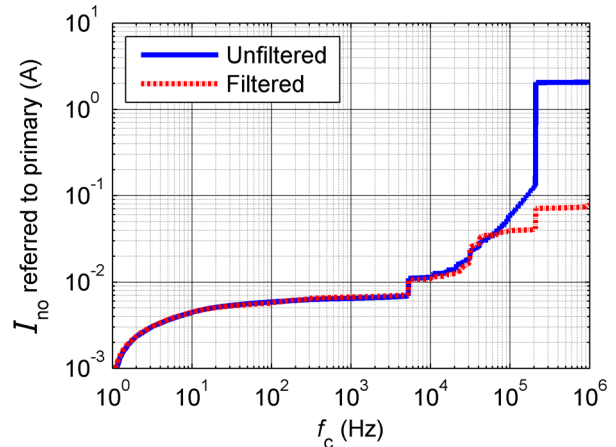

Figure 14: Typical total output current noise (primary referred, rms) with $R_M = 1 \Omega$ (f_c is upper cut off frequency of bandpass, low cut off frequency is 1 Hz). Filtered output was measured with 10 kHz 1st order low pass filter.

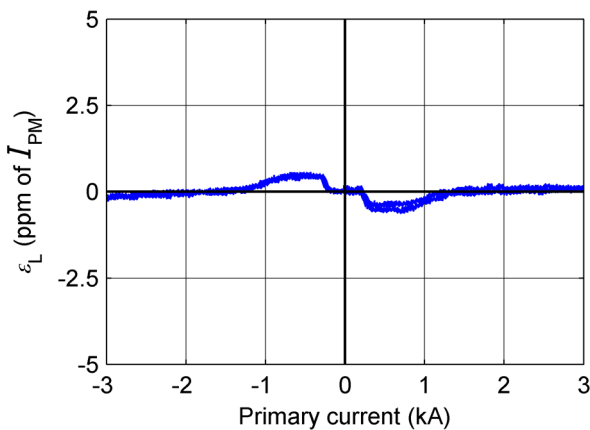

Figure 15: Typical linearity error

Figure 13 (noise voltage density) shows that there are two discrete frequencies in the output. Figure 14 confirms that because there are steps in the total output current noise at around 6 and 200 kHz. The 10 kHz filter reduces by a large amount the high frequency noise. To calculate the noise in a frequency band f_1 to f_2 , the formula is:

$$I_{no}(f_1 \text{ to } f_2) = \sqrt{I_{no}(f_2)^2 - I_{no}(f_1)^2}$$

with $I_{no}(f)$ read from figure 14 (typical, rms value).

Example:

What is the noise from 10 to 1000 Hz?

Figure 14 gives $I_{no}(10 \text{ Hz}) = 4 \text{ mA}$ and $I_{no}(1000 \text{ Hz}) = 6.5 \text{ mA}$. The output current noise (rms) is therefore.

$$\sqrt{(6.5 \cdot 10^{-3})^2 - (4 \cdot 10^{-3})^2} = 5.1 \text{ mA referred to primary}$$

Typical performance characteristics

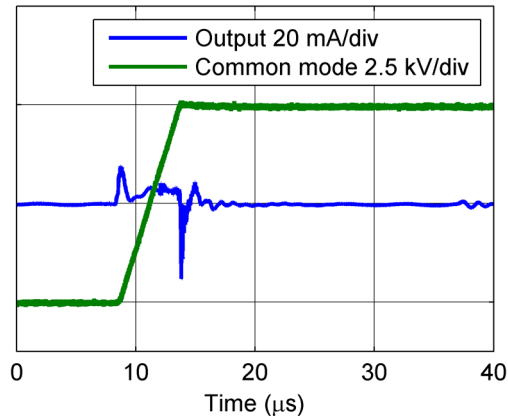

Figure 16: Typical common mode perturbation, unfiltered output
(5 kV step with 1 kV/ μ s, $R_M = 1 \Omega$)

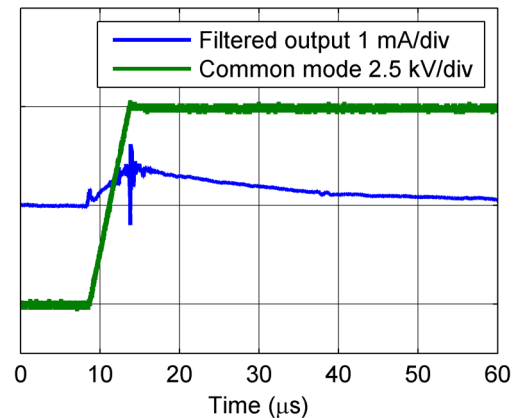

Figure 17: Typical common mode perturbation with 10 kHz 1st order low pass filter on the output
(5 kV step with 1 kV/ μ s, $R_M = 1 \Omega$)

Definition of typical, minimum and maximum values

Minimum and maximum values for specified limiting and safety conditions have to be understood as such as well as values shown in “typical” graphs.

On the other hand, measured values are part of a statistical distribution that can be specified by an interval with upper and lower limits and a probability for measured values to lie within this interval.

Unless otherwise stated (e.g. “100 % tested”), the LEM definition for such intervals designated with “min” and “max” is that the probability for values of samples to lie in this interval is 99.73 %.

For a normal (Gaussian) distribution, this corresponds to an interval between -3 sigma and +3 sigma.

If “typical” values are not obviously mean or average values, those values are defined to delimit intervals with a probability of 68.27 %, corresponding to an interval between -sigma and +sigma for a normal distribution.

Typical, maximal and minimal values are determined during the initial characterization of the product.

General description

The ITC 2000 transducer is a closed loop current transducer based on the fluxgate principle for the isolated yet accurate measurement of currents up to 3 kA. Its Class D power stage greatly reduces the power consumption compared to standard designs and allows function without limitation with an ambient temperature from -40 to 85 °C.

Closed loop transducer

The ITC is a compensated current transducer (also called closed loop): it means that the current in the secondary coil is regulated so that the magnetic flux it creates in the main toroidal core compensates exactly the flux generated by the primary current.

This implies that the magnetic potential (ampere-turns) of the two coils are identical, hence:

$$N_p \cdot I_p = N_s \cdot I_s \text{ or } I_s = I_p \cdot N_p / N_s \text{ also written } I_s = G \cdot I_p \text{ with } -N_p \text{ and } N_s \text{ the turns numbers of the primary and compensation (or secondary) windings, } -G = N_p / N_s \text{ the sensitivity of the transducer}$$

Consequently, the secondary current I_s is the exact image of the primary current I_p being measured. Inserting a measuring resistor R_m in series with the compensation coil (see figure 18) creates an output voltage that is an exact image of the measured current from DC to high frequencies.

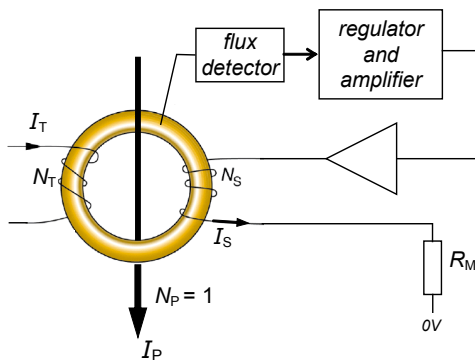

Figure 18: Principle of ITC transducer

Fluxgate

A fluxgate detector measures the resulting magnetic flux. It uses an inductor, the fluxgate, composed of a thin toroid with a coil around it and placed in the center of the main core halves (see figure 19).

The electronics saturate the fluxgate in both directions and analyzes the symmetry of the fluxgate’s saturation currents to extract the actual flux value.

The fluxgate detector developed for the ITC is very stable in temperature, which gives the ITC its outstanding accuracy stability.

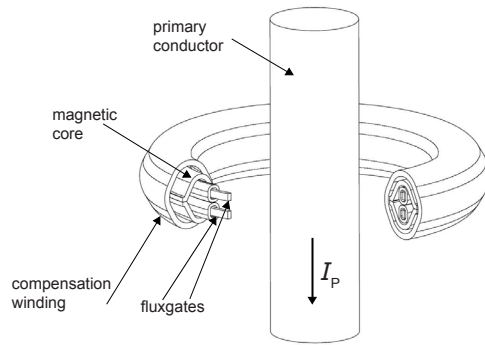

Figure 19: ITC head construction

Output stage

The output stage of the ITC uses a Class D amplifier to limit both the power consumption of the transducer and its losses. In this type of switched-mode amplifier both transistors of the output bridge are turned on and off alternatively by a PWM signal as shown in figure 20 and 21. The losses are therefore only caused by the $R_{ds(on)}$ and the turn-on and -off losses of the transistors T1H and T1L. Compared to the industry standard, which is the Class AB (linear), the Class D allows the losses in the transistors to be reduced by a factor close to 10, removing the need for large heatsinks and improving the reliability of the electronics. A built-in second order filter attenuates the harmonics to a very low level.

The ITC moreover uses a proprietary technique to balance the supply currents which results in reduced and almost equal supply currents drawn from both supplies whatever the input current measured (I_H and I_L in figure 20). See also figure 8.

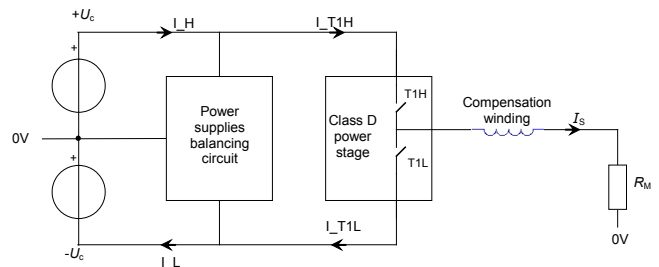

Figure 20: Power stage principle

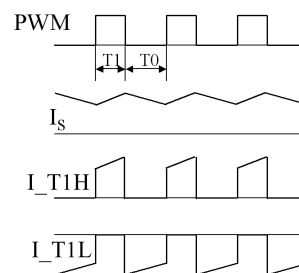

Figure 21: Current in transistors

General description

Overload behavior and /INVALID output

The electronics cannot maintain the flux compensation if the primary current becomes higher than the measuring range. If this state lasts too long the fluxgate detector becomes completely saturated and unable to measure the flux error. When this happens, the transducer stops for 300 to 500 ms and then sweeps the output current to find the point at which compensation is correct again and the normal function can resume. This behavior is shown in figure 22.

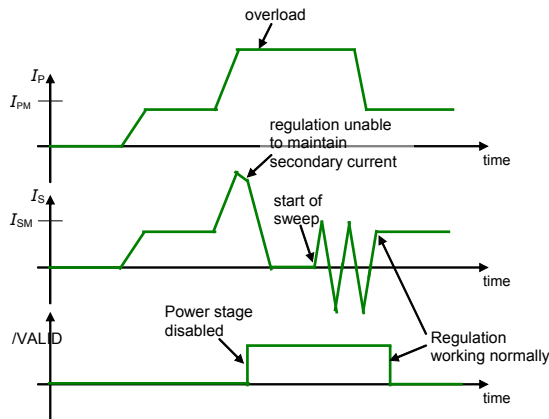

Figure 22: Overload behaviour

The logic output /INVALID is an open collector. The pull-up resistor R_{pu} is external to the transducer (see figure 23). It is activated (pulled to 0V) to indicate that the regulation of the output current works normally. It is deactivated (pulled to the high level) to indicate that the output current is not the exact image of the primary current. It happens during the start-up of the transducer, after a large overcurrent, if there is an internal fault or if the measuring resistance is disconnected while a primary current is present.

The transducer is protected against overloads up to 100 kA without duration limit. In such a case, it will stop to protect itself and /INVALID will be deactivated. Even if the compensation winding current is very high thanks to the transformer effect, there is no high current drawn from the supplies or reinjected in the supplies. For very low measuring resistances values, there might be a current close to $I_p \cdot G$ in the measuring resistance until the core saturates (typically 15 ms for 100 kA).

Test winding

A test winding is wound around the compensation winding. It allows simulating a primary current to test the function and accuracy of the transducer at 10% of its nominal. The output current I_s for a test current I_T is $I_s = N_T/N_S \cdot I_T$. The current injected in the test winding must be generated by a current source (high impedance). When the test winding is not used, it must stay opened.

Performance parameters definition

The schematic used to measure all electrical parameters are:

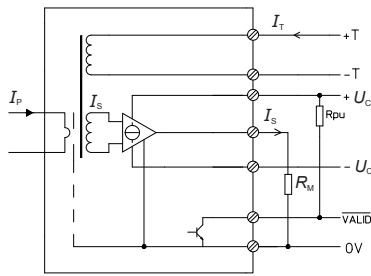

Figure 23: Standard characterization schematics for current output transducers

Transducer simplified model

The static model of the transducer at temperature T_A is:

$$I_S = G \cdot I_P + \text{error}$$

In which

$$\text{error} = I_{OE} + I_{OT}(T_A) + \varepsilon_G \cdot G \cdot I_P + \varepsilon_{GT}(T_A) \cdot G \cdot I_P + \varepsilon_L \cdot G \cdot I_{PM} + I_{OM}$$

I_S	: secondary current (A)
G	: sensitivity of the transducer (A/A)
I_P	: primary current (A)
I_{PM}	: primary current, measuring range (A)
T_A	: ambient operating temperature (°C)
I_{OE}	: electrical offset current (A)
I_{OM}	: magnetic offset current (A)
$I_{OT}(T_A)$: temperature variation of I_{OE} at temperature T_A (A)
ε_G	: sensitivity error at 25 °C
$\varepsilon_{GT}(T_A)$: thermal drift of sensitivity at temperature T_A
ε_L	: linearity error

This is the absolute maximum error. As all errors are independent, a more realistic way to calculate the error would be to use the following formula:

$$\text{error} = \sqrt{\sum (\text{error component})^2}$$

Sensitivity and linearity

To measure sensitivity and linearity, the primary current (DC) is cycled from 0 to I_{PM} , then to $-I_{PM}$ and back to 0 (equally spaced $I_{PM}/10$ steps).

The sensitivity G is defined as the slope of the linear regression line for a cycle between $\pm I_{PM}$.

The linearity error ε_L is the maximum positive or negative difference between the measured points and the linear regression line, expressed in % of the maximum measured value.

Magnetic offset

The magnetic offset I_{OM} is the change of offset after a given current has been applied to the input. It is included in the linearity error as long as the transducer remains in its measuring range. Due to its working principle, this type of transducer has small magnetic offset current.

Electrical offset

The electrical offset current I_{OE} is the residual output current when the input current is zero (magnetic offset removed).

The temperature variation I_{OT} of the electrical offset current I_{OE} is the variation of the electrical offset from 25 °C to the considered temperature.

Overall accuracy

The overall accuracy X_G is the error at a given current (I_{PN} if not mentioned), relative to the rated value I_{PN} or to the reading. It includes all errors mentioned above.

Response and reaction times

The response time t_r and the reaction time t_{ra} are shown in the next figure.

Both slightly depend on the primary current di/dt . They are measured at nominal current.

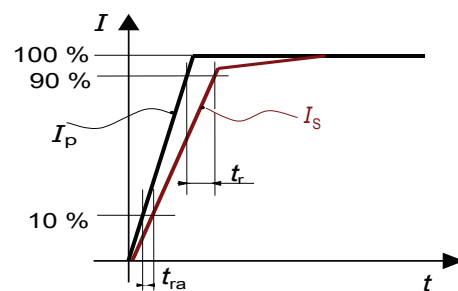
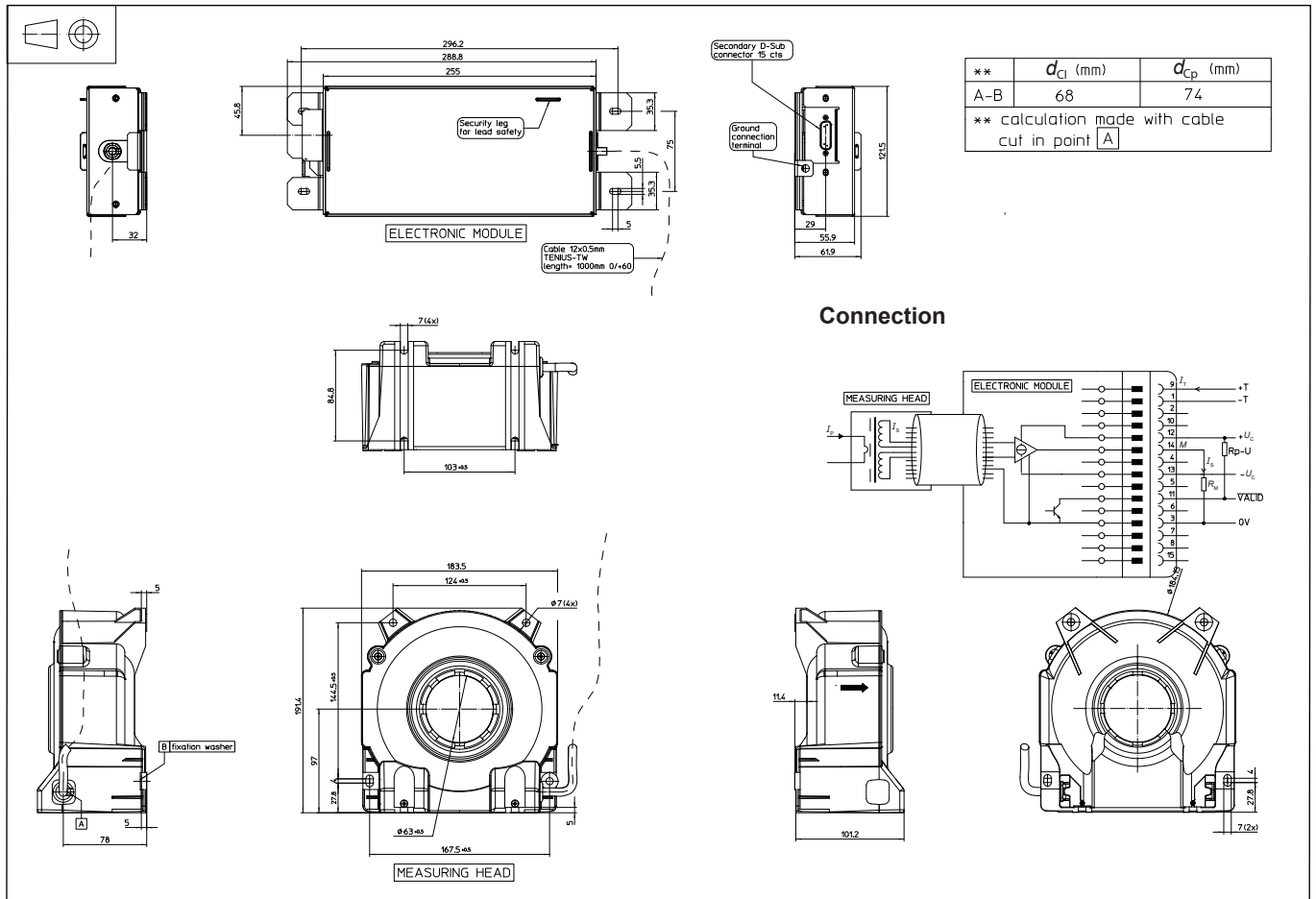

Figure 24: Response time t_r and reaction time t_{ra}

Dimensions (in mm)



Mechanical characteristics

- General tolerance ± 1 mm
- Measuring head
 - Transducer fastening 4 slots or holes $\varnothing 7$ mm
 - 4 M6 steel screws
 - Recommended fastening torque 5 N·m (± 10 %)
- Electronic module
 - Output connection D-Sub male connector
 - 15 cts with M3 hexagonal locking screws
- Electronic module fastening 4 M5 screw
- Recommended fastening torque 5 N·m (± 10 %)

Remarks

- I_s is positive when I_p flows in the direction of arrow.
- The secondary cables also have to be routed together all the way.
- Installation of the transducer is to be done without primary or secondary voltage present.
- Maximum temperature of primary conductor: see page 2
- Installation of the transducer must be done unless otherwise specified on the datasheet, according to LEM Transducer Generic Mounting Rules. Please refer to LEM document N°ANE120504 available on our Web site: [Products/Product Documentation](#).

Safety



This transducer must be used in electric/electronic equipment with respect to applicable standards and safety requirements in accordance with the manufacturer's operating instructions.



Caution, risk of electrical shock

When operating the transducer, certain parts of the module can carry hazardous voltage (eg. primary busbar, power supply). Ignoring this warning can lead to injury and/or cause serious damage. This transducer is a build-in device, whose conducting parts must be inaccessible after installation. A protective housing or additional shield could be used. Main supply must be able to be disconnected.