

**Authorized Distributor:**  
**Darrah Electric Company**  
**www.darrahelectric.com**

**Single IGBTMOD™**  
**A-Series Module**  
**400 Amperes/1200 Volts**

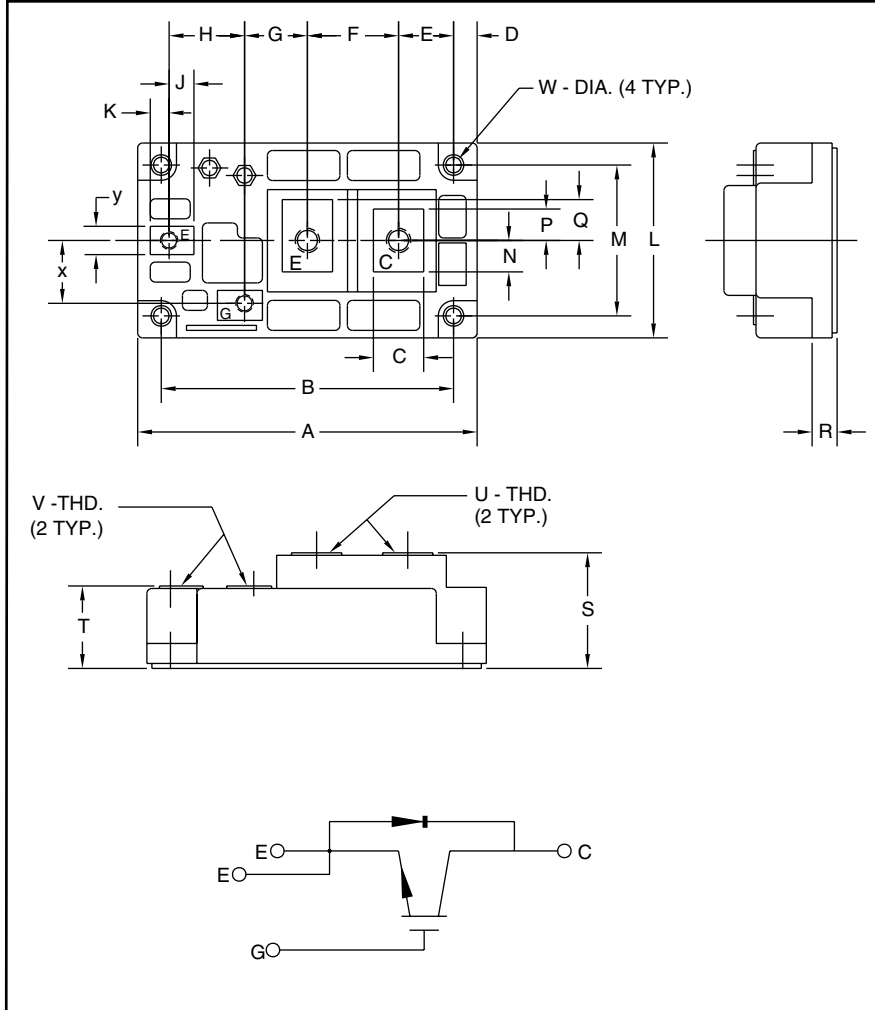

**Outline Drawing and Circuit Diagram**

Dimensions	Inches	Millimeters
A	4.25	108.0
B	3.66	93.0
C	0.63	16.0
D	0.30	7.5
E	0.69	17.5
F	1.14	29.0
G	0.79	20.0
H	0.94	24.0
J	0.31	7.9
K	0.24	6.0
L	2.44	62.0
M	1.89	48.0

Dimensions	Inches	Millimeters
N	0.39	10.0
P	0.39	10.0
Q	0.51	13.0
R	0.33	8.5
S	1.42	36.0
T	1.02	25.8
U	M6 Metric	M6
V	M4 Metric	M4
W	0.256	6.5
X	0.79	20.0
Y	0.35	9.0



**Description:**

Powerex IGBTMOD™ Modules are designed for use in switching applications. Each module consists of one IGBT Transistor in a single configuration with a reverse connected super-fast recovery free-wheel diode. All components and interconnects are isolated from the heat sinking baseplate, offering simplified system assembly and thermal management.

**Features:**

- Low Drive Power
- Low  $V_{CE(sat)}$
- Discrete Super-Fast Recovery Free-Wheel Diode
- Isolated Baseplate for Easy Heat Sinking

**Applications:**

- DC Chopper
- Inverter
- UPS
- Forklift

**Ordering Information:**

Example: Select the complete part module number you desire from the table below - i.e. CM400HA-24A is a 1200V ( $V_{CES}$ ), 400 Ampere Single IGBTMOD™ Power Module.

Type	Current Rating Amperes	$V_{CES}$ Volts (x 50)
CM	400	24



Powerex, Inc., 200 E. Hillis Street, Youngwood, Pennsylvania 15697-1800 (724) 925-7272

**CM400HA-24A**  
**Single IGBTMOD™ A-Series Module**  
 400 Amperes/1200 Volts

**Absolute Maximum Ratings,  $T_j = 25^\circ\text{C}$  unless otherwise specified**

Ratings	Symbol	CM400HA-24A	Units
Junction Temperature	$T_j$	-40 to 150	$^\circ\text{C}$
Storage Temperature	$T_{\text{stg}}$	-40 to 125	$^\circ\text{C}$
Collector-Emitter Voltage (G-E Short)	$V_{\text{CES}}$	1200	Volts
Gate-Emitter Voltage (C-E Short)	$V_{\text{GES}}$	$\pm 20$	Volts
Collector Current (DC, $T_C = 87^\circ\text{C}^*$ )	$I_C$	400	Amperes
Peak Collector Current	$I_{\text{CM}}$	800**	Amperes
Emitter Current*** ( $T_C = 25^\circ\text{C}$ )	$I_E$	400	Amperes
Peak Emitter Current***	$I_{\text{EM}}$	800**	Amperes
Maximum Collector Dissipation ( $T_C = 25^\circ\text{C}^*$ , $T_j \leq 150^\circ\text{C}$ )	$P_C$	2350	Watts
Mounting Torque, M6 Main Terminal	—	26	in-lb
Mounting Torque, M6 Mounting	—	26	in-lb
Mounting Torque, M4 G(E) Terminal	—	13	in-lb
Weight	—	480	Grams
Isolation Voltage (Main Terminal to Baseplate, AC 1 min.)	$V_{\text{ISO}}$	2500	Volts

**Static Electrical Characteristics,  $T_j = 25^\circ\text{C}$  unless otherwise specified**

Characteristics	Symbol	Test Conditions	Min.	Typ.	Max.	Units
Collector-Cutoff Current	$I_{\text{CES}}$	$V_{\text{CE}} = V_{\text{CES}}, V_{\text{GE}} = 0\text{V}$	—	—	1.0	mA
Gate Leakage Current	$I_{\text{GES}}$	$V_{\text{GE}} = V_{\text{GES}}, V_{\text{CE}} = 0\text{V}$	—	—	0.5	$\mu\text{A}$
Gate-Emitter Threshold Voltage	$V_{\text{GE(th)}}$	$I_C = 40\text{mA}, V_{\text{CE}} = 10\text{V}$	6.0	7.0	8.0	Volts
Collector-Emitter Saturation Voltage	$V_{\text{CE(sat)}}$	$I_C = 400\text{A}, V_{\text{GE}} = 15\text{V}, T_j = 25^\circ\text{C}$	—	2.1	3.0	Volts
		$I_C = 400\text{A}, V_{\text{GE}} = 15\text{V}, T_j = 125^\circ\text{C}$	—	2.4	—	Volts
Total Gate Charge	$Q_G$	$V_{\text{CC}} = 600\text{V}, I_C = 400\text{A}, V_{\text{GE}} = 15\text{V}$	—	2000	—	nC
Emitter-Collector Voltage**	$V_{\text{EC}}$	$I_E = 400\text{A}, V_{\text{GE}} = 0\text{V}$	—	—	3.8	Volts

**Dynamic Electrical Characteristics,  $T_j = 25^\circ\text{C}$  unless otherwise specified**

Characteristics	Symbol	Test Conditions	Min.	Typ.	Max.	Units
Input Capacitance	$C_{\text{ies}}$		—	—	70	nf
Output Capacitance	$C_{\text{oes}}$	$V_{\text{CE}} = 10\text{V}, V_{\text{GE}} = 0\text{V}$	—	—	6	nf
Reverse Transfer Capacitance	$C_{\text{res}}$		—	—	1.4	nf
Inductive Load	Turn-on Delay Time	$V_{\text{CC}} = 600\text{V}, I_C = 400\text{A},$	—	—	550	ns
	Rise Time					
Switch Time	Turn-off Delay Time	$V_{\text{GE1}} = V_{\text{GE2}} = 15\text{V}, R_G = 0.78\Omega,$	—	—	600	ns
	Fall Time					
Diode Reverse Recovery Time***	$t_{\text{rr}}$	Inductive Load	—	—	350	ns
Diode Reverse Recovery Charge***	$Q_{\text{rr}}$	Switching Operation,	—	—	250	ns
		$I_E = 400\text{A}$	—	14.7	—	$\mu\text{C}$

\* $T_C, T_f$  measured point is just under the chips.

\*\*Pulse width and repetition rate should be such that device junction temperature ( $T_j$ ) does not exceed  $T_{j(\text{max})}$  rating.

\*\*\*Represents characteristics of the anti-parallel, emitter-to-collector free-wheel diode (FWDI).



Powerex, Inc., 200 E. Hillis Street, Youngwood, Pennsylvania 15697-1800 (724) 925-7272

**CM400HA-24A**  
**Single IGBTMOD™ A-Series Module**  
 400 Amperes/1200 Volts

**Thermal and Mechanical Characteristics,  $T_j = 25^\circ\text{C}$  unless otherwise specified**

Characteristics	Symbol	Test Conditions	Min.	Typ.	Max.	Units
Thermal Resistance, Junction to Case*	$R_{th(j-c)Q}$	Per IGBT	—	—	0.053	$^\circ\text{C/W}$
Thermal Resistance, Junction to Case*	$R_{th(j-c)D}$	Per FWDi	—	—	0.080	$^\circ\text{C/W}$
Contact Thermal Resistance	$R_{th(c-f)}$	Thermal Grease Applied	—	0.02	—	$^\circ\text{C/W}$
External Gate Resistance	$R_G$		0.78	—	10	$\Omega$

\* $T_C$ ,  $T_f$  measured point is just under the chips.

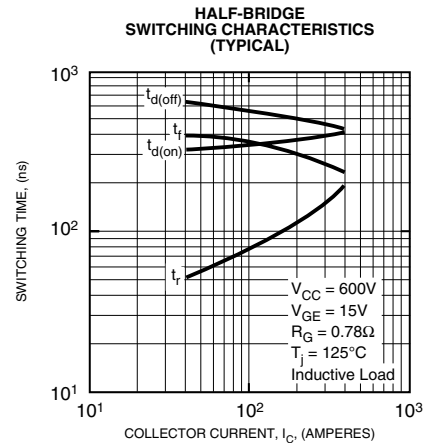
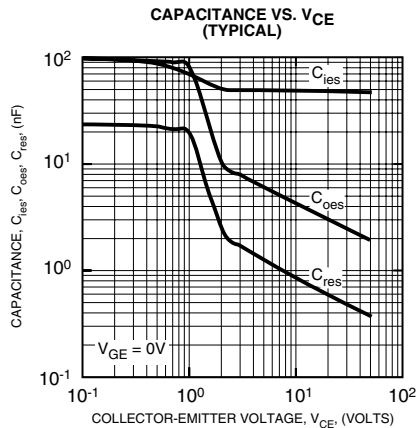
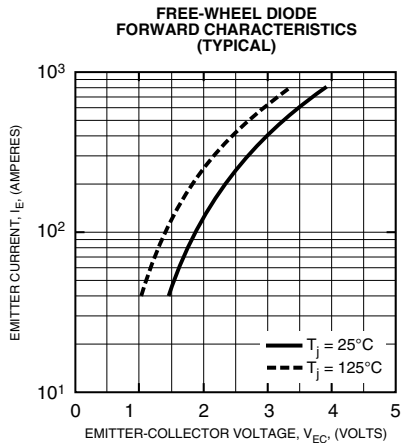
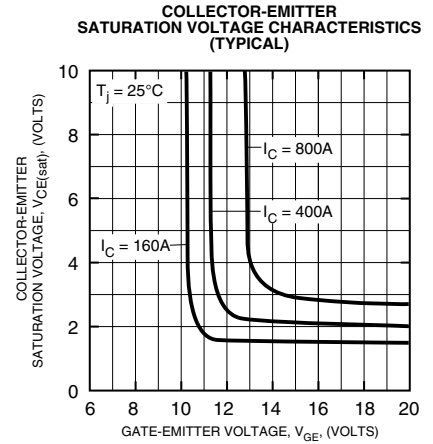
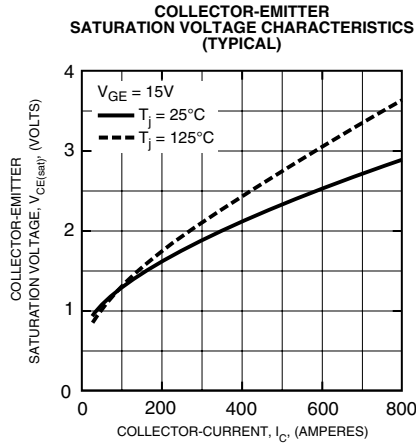
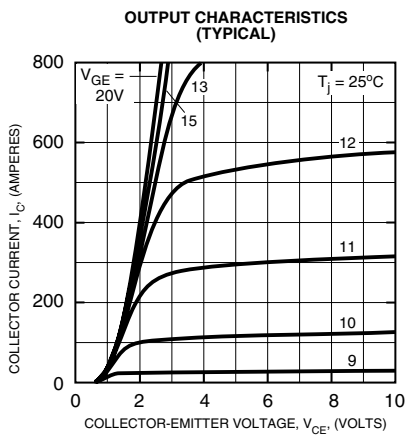

**CM400HA-24A**  
**Single IGBTMOD™ A-Series Module**  
 400 Amperes/1200 Volts

**REVERSE RECOVERY CHARACTERISTICS (TYPICAL)**

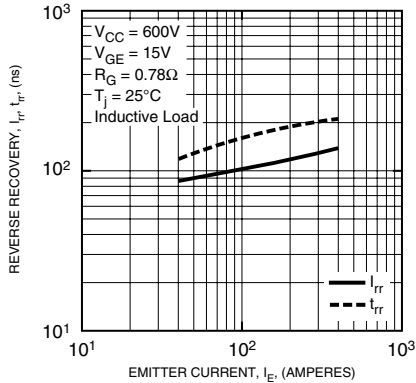

**GATE CHARGE VS.  $V_{GE}$**

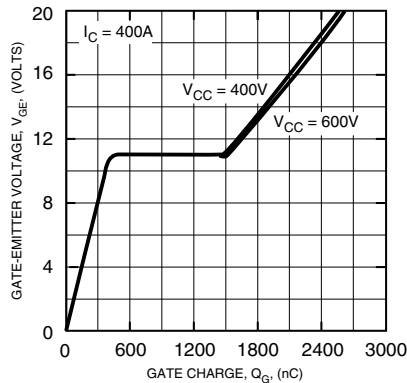

**SWITCHING LOSS VS. COLLECTOR CURRENT (TYPICAL)**

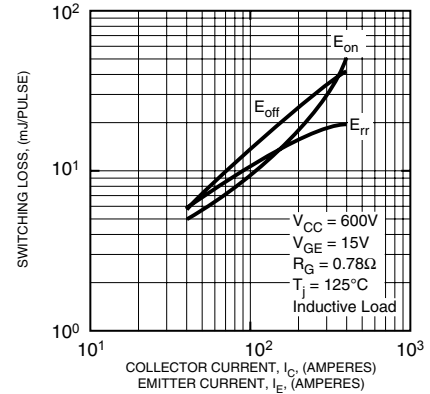

**SWITCHING LOSS VS. GATE RESISTANCE (TYPICAL)**

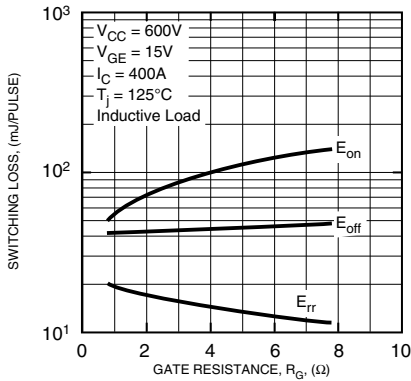

**TRANSIENT THERMAL IMPEDANCE CHARACTERISTICS (IGBT & FWDI)**

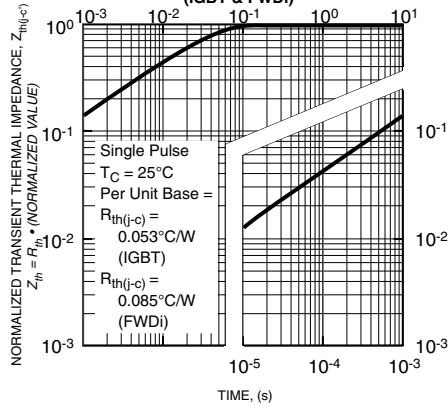

**Darrah Electric Company**  
 5914 Merrill Avenue  
 Cleveland, Ohio 44102 USA  
 216-631-0912  
 216-631-0440 fax  
 www.darrahelectric.com

