

$V_{\text{DRM}}$	=	4500 V
$I_{\text{TGQM}}$	=	3000 A
$I_{\text{TSM}}$	=	$24 \times 10^3$ A
$V_{\text{T0}}$	=	2.2 V
$r_{\text{T}}$	=	0.6 m $\Omega$
$V_{\text{Dclink}}$	=	2800 V

# Asymmetric Gate turn-off Thyristor 5SGA 30J4502

Doc. No. 5SYA1202-03 Jan. 03

- Patented free-floating silicon technology
- Low on-state and switching losses
- Annular gate electrode
- Industry standard housing
- Cosmic radiation withstand rating

**Authorized Distributor:**  
Darrah Electric Company  
[www.darrahelectric.com](http://www.darrahelectric.com)

## Blocking

*Maximum rated values <sup>1)</sup>*

Parameter	Symbol	Conditions	min	typ	max	Unit
Repetitive peak off-state voltage	$V_{\text{DRM}}$	$V_{\text{GR}} \geq 2$ V			4500	V
Repetitive peak reverse voltage	$V_{\text{RRM}}$				17	V
Permanent DC voltage for 100 FIT failure rate	$V_{\text{Dclink}}$	Ambient cosmic radiation at sea level in open air.			2800	V

*Characteristic values*

Parameter	Symbol	Conditions	min	typ	max	Unit
Repetitive peak off-state current	$I_{\text{DRM}}$	$V_{\text{D}} = V_{\text{DRM}}, V_{\text{GR}} \geq 2$ V			60	mA
Repetitive peak reverse current	$I_{\text{RRM}}$	$V_{\text{R}} = V_{\text{RRM}}, R_{\text{GK}} = \infty \Omega$			20	mA

## Mechanical data

*Maximum rated values <sup>1)</sup>*

Parameter	Symbol	Conditions	min	typ	max	Unit
Mounting force	$F_{\text{m}}$		36	40	44	kN

*Characteristic values*

Parameter	Symbol	Conditions	min	typ	max	Unit
Pole-piece diameter	$D_{\text{p}}$	$\pm 0.1$ mm		75		mm
Housing thickness	H	$\pm 0.5$ mm		26		mm
Weight	m			1.3		kg
Surface creepage distance	$D_{\text{s}}$	Anode to Gate	33			mm
Air strike distance	$D_{\text{a}}$	Anode to Gate	15			mm

1) Maximum rated values indicate limits beyond which damage to the device may occur

ABB Switzerland Ltd, Semiconductors reserves the right to change specifications without notice.



# GTO Data

## On-state

Maximum rated values <sup>1)</sup>

Parameter	Symbol	Conditions	min	typ	max	Unit
Max. average on-state current	$I_{TAVM}$	Half sine wave, $T_C = 85^\circ\text{C}$			930	A
Max. RMS on-state current	$I_{TRMS}$				1460	A
Max. peak non-repetitive surge current	$I_{TSM}$	$t_p = 10\text{ ms}$ , $T_{vj} = 125^\circ\text{C}$ , sine wave After Surge: $V_D = V_R = 0\text{ V}$			$24 \times 10^3$	A
Limiting load integral	$I^2t$				$2.88 \times 10^6$	$\text{A}^2\text{s}$
Max. peak non-repetitive surge current	$I_{TSM}$	$t_p = 1\text{ ms}$ , $T_{vj} = 125^\circ\text{C}$ , sine wave After Surge: $V_D = V_R = 0\text{ V}$			$40 \times 10^3$	A
Limiting load integral	$I^2t$				$800 \times 10^3$	$\text{A}^2\text{s}$

Characteristic values

Parameter	Symbol	Conditions	min	typ	max	Unit
On-state voltage	$V_T$	$I_T = 3000\text{ A}$ , $T_{vj} = 125^\circ\text{C}$			4	V
Threshold voltage	$V_{(T0)}$	$T_{vj} = 125^\circ\text{C}$			2.2	V
Slope resistance	$r_T$	$I_T = 300 \dots 4000\text{ A}$			0.6	$\text{m}\Omega$
Holding current	$I_H$	$T_{vj} = 25^\circ\text{C}$			50	A

## Turn-on switching

Maximum rated values <sup>1)</sup>

Parameter	Symbol	Conditions	min	typ	max	Unit
Critical rate of rise of on-state current	$di_T/dt_{cr}$	$T_{vj} = 125^\circ\text{C}$ , $f = 200\text{ Hz}$			400	$\text{A}/\mu\text{s}$
Critical rate of rise of on-state current	$di_T/dt_{cr}$	$I_T = 3000\text{ A}$ , $I_{GM} = 30\text{ A}$ , $di_G/dt = 20\text{ A}/\mu\text{s}$ , $f = 1\text{ Hz}$			800	$\text{A}/\mu\text{s}$
Min. on-time	$t_{on}$		100			$\mu\text{s}$

Characteristic values

Parameter	Symbol	Conditions	min	typ	max	Unit
Turn-on delay time	$t_d$	$V_D = 0.5 V_{DRM}$ , $T_{vj} = 125^\circ\text{C}$			3	$\mu\text{s}$
Rise time	$t_r$	$I_T = 3000\text{ A}$ , $di/dt = 200\text{ A}/\mu\text{s}$ , $I_{GM} = 30\text{ A}$ , $di_G/dt = 20\text{ A}/\mu\text{s}$ , $C_S = 6\text{ }\mu\text{F}$ , $R_S = 5\text{ }\Omega$			6	$\mu\text{s}$
Turn-on energy per pulse	$E_{on}$				3.6	J

## Turn-off switching

Maximum rated values <sup>1)</sup>

Parameter	Symbol	Conditions	min	typ	max	Unit
Max. controllable turn-off current	$I_{TGQM}$	$V_{DM} \leq V_{DRM}$ , $di_{GQ}/dt = 40\text{ A}/\mu\text{s}$ , $C_S = 6\text{ }\mu\text{F}$ , $L_S \leq 0.3\text{ }\mu\text{H}$			3000	A
Min. off-time	$t_{off}$		80			$\mu\text{s}$

Characteristic values

Parameter	Symbol	Conditions	min	typ	max	Unit
Storage time	$t_s$	$V_D = 0.5 V_{DRM}$ , $T_{vj} = 125^\circ\text{C}$			25	$\mu\text{s}$
Fall time	$t_f$	$V_{DM} \leq V_{DRM}$ , $di_{GQ}/dt = 40\text{ A}/\mu\text{s}$ , $I_{TGQ} = I_{TGQM}$			3	$\mu\text{s}$
Turn-on energy per pulse	$E_{off}$	$R_S = 5\text{ }\Omega$ , $C_S = 6\text{ }\mu\text{F}$ , $L_S = 0.3\text{ }\mu\text{H}$			13	J
Peak turn-off gate current	$I_{GQM}$				900	A

## Gate

### Maximum rated values <sup>1)</sup>

Parameter	Symbol	Conditions	min	typ	max	Unit
Repetitive peak reverse voltage	V <sub>GRM</sub>				17	V
Repetitive peak reverse current	I <sub>GRM</sub>	V <sub>GR</sub> = V <sub>GRM</sub>			20	mA

### Characteristic values

Parameter	Symbol	Conditions	min	typ	max	Unit
Gate trigger voltage	V <sub>GT</sub>	T <sub>vj</sub> = 25°C,		1		V
Gate trigger current	I <sub>GT</sub>	V <sub>D</sub> = 24 V, R <sub>A</sub> = 0.1 Ω		3		A

## Thermal

### Maximum rated values <sup>1)</sup>

Parameter	Symbol	Conditions	min	typ	max	Unit
Junction operating temperature	T <sub>vj</sub>		-40		125	°C
Storage temperature range	T <sub>stg</sub>		-40		125	°C

### Characteristic values

Parameter	Symbol	Conditions	min	typ	max	Unit
Thermal resistance junction to case	R <sub>th(jc)</sub>	Double side cooled			12	K/kW
	R <sub>th(jc)A</sub>	Anode side cooled			22	K/kW
	R <sub>th(jc)C</sub>	Cathode side cooled			27	K/kW
Thermal resistance case to heatsink (Double side cooled)	R <sub>th(ch)</sub>	Single side cooled			6	K/kW
	R <sub>th(ch)</sub>	Double side cooled			3	K/kW

Analytical function for transient thermal impedance:

$$Z_{thJC}(t) = \sum_{i=1}^n R_i(1 - e^{-t/\tau_i})$$

i	1	2	3	4
R <sub>i</sub> (K/kW)	5.400	4.500	1.700	0.400
τ <sub>i</sub> (s)	1.2000	0.1700	0.0100	0.0010

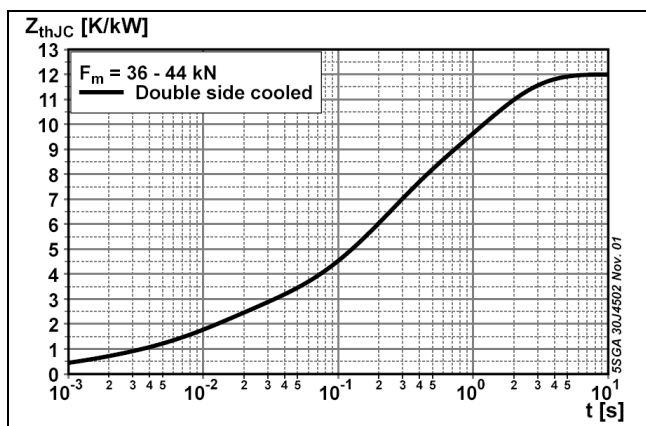

Fig. 1 Transient thermal impedance, junction to case.

**Darrah Electric Company**  
 5914 Merrill Avenue  
 Cleveland, Ohio 44102 USA  
 216-631-0912  
 216-631-0440 fax  
 www.darrahelectric.com



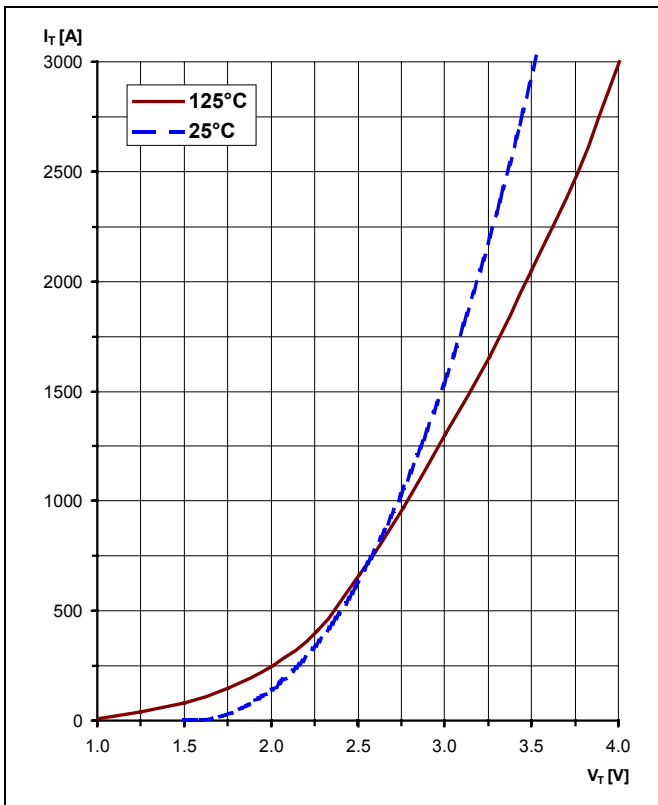

Fig. 2 On-state characteristics.

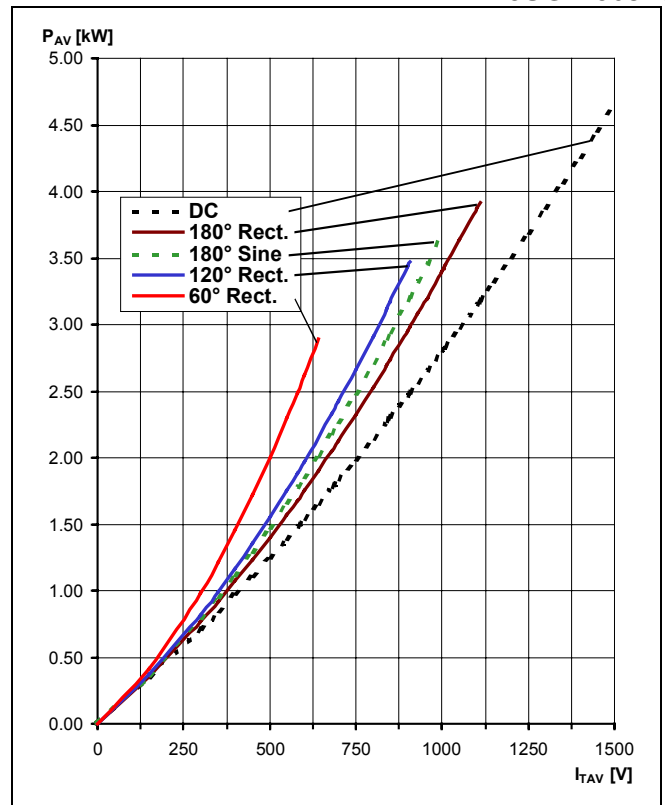

Fig. 3 Average on-state power dissipation vs. average on-state current..

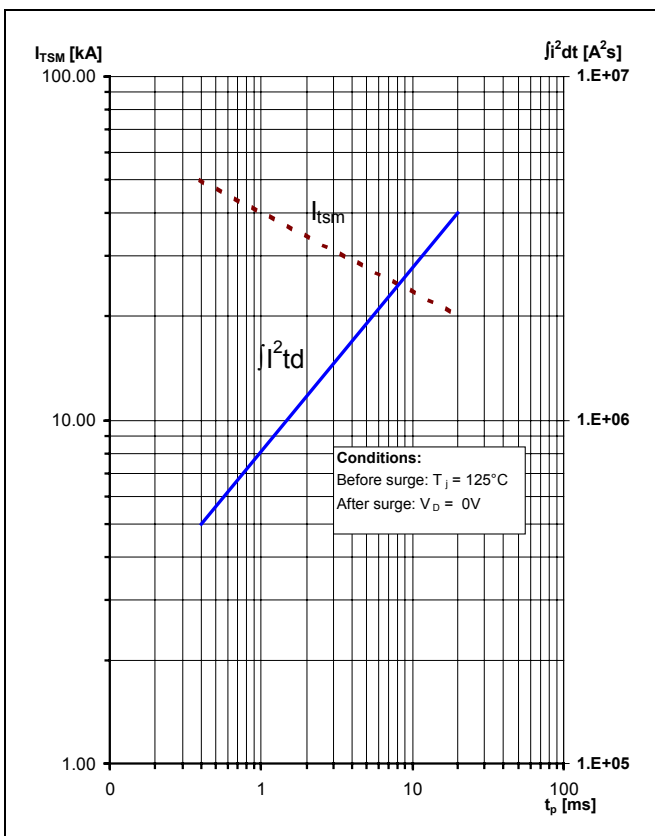

Fig. 4 Surge current and fusing integral vs. pulse width.

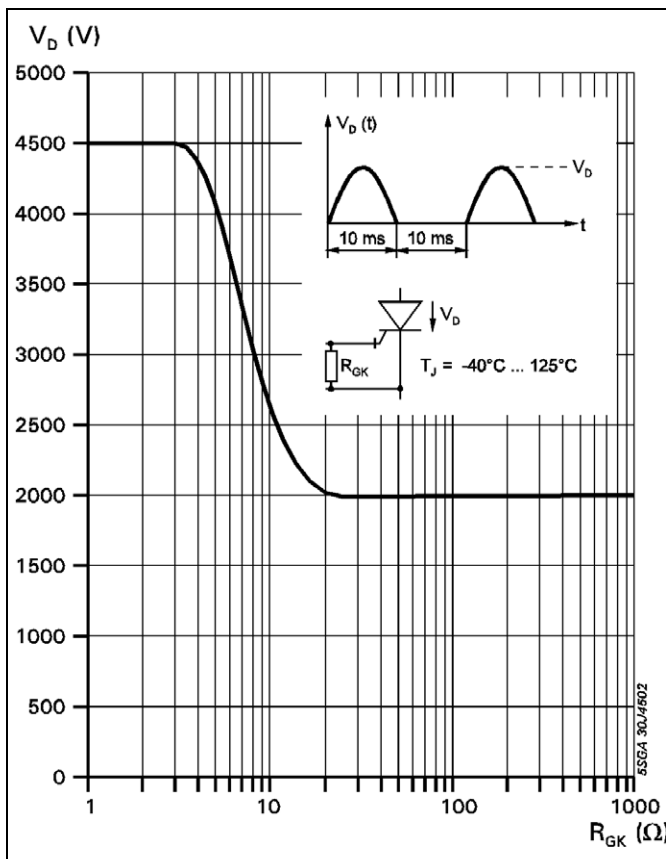

Fig. 5 Forward blocking voltage vs. gate-cathode resistance..

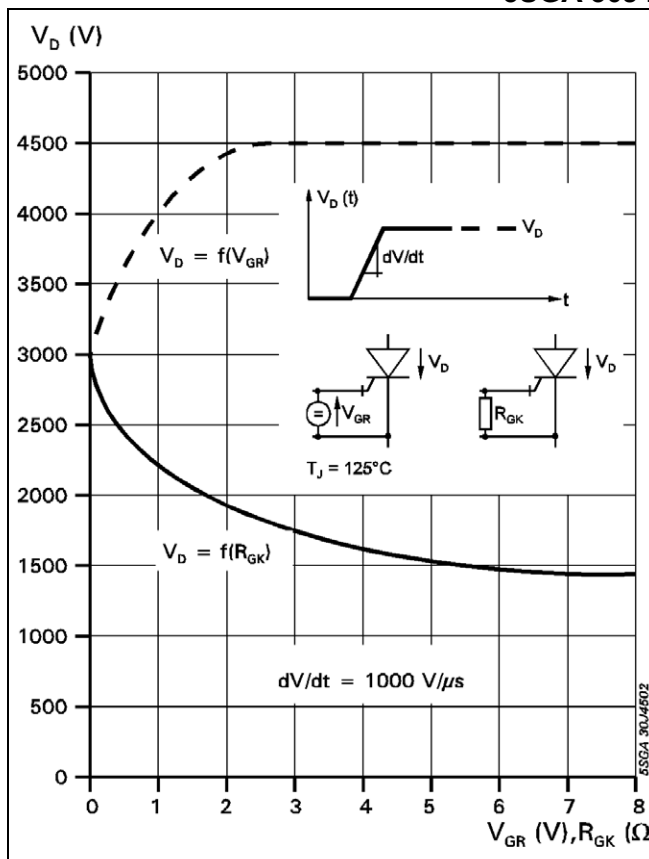

Fig. 6 Static dv/dt capability: Forward blocking voltage vs. neg. gate voltage or gate cathode resistance.

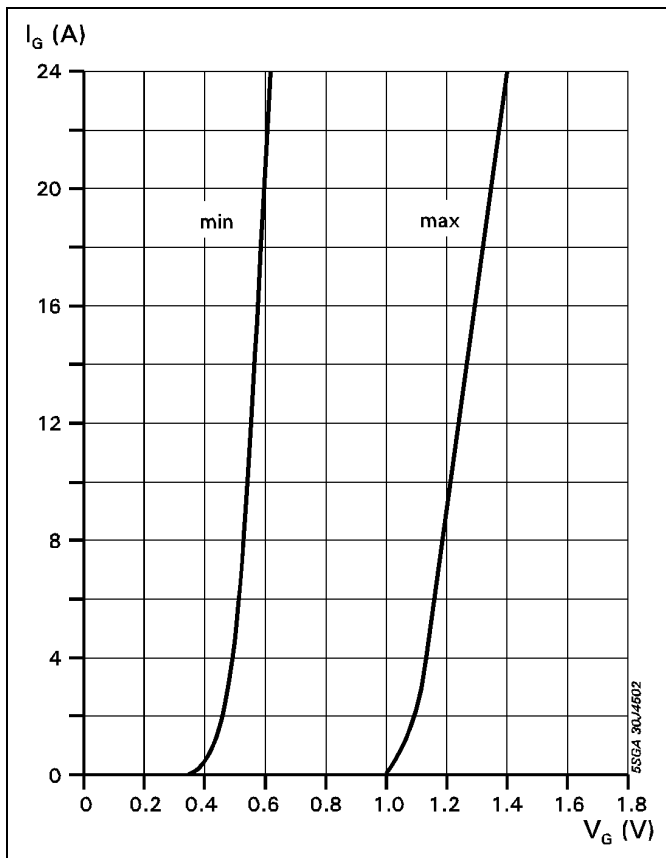

Fig. 7 Forward gate current vs. forward gate voltage.

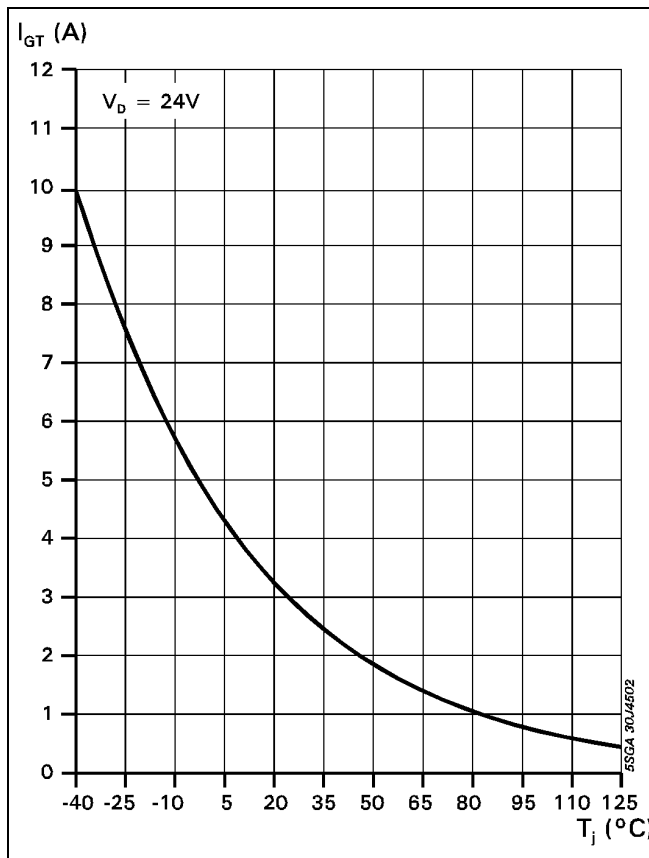

Fig. 8 Gate trigger current vs. junction temperature

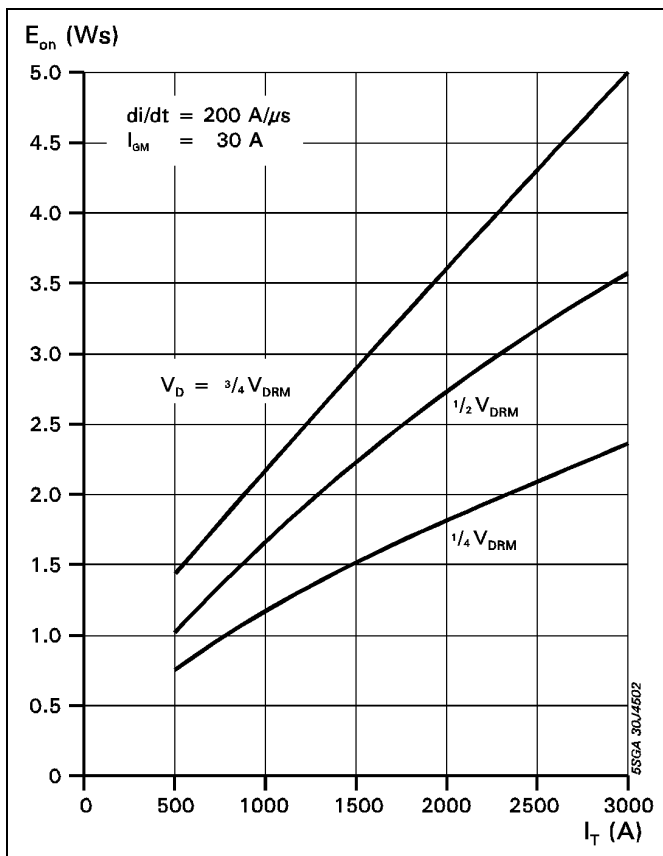

Fig. 9 Turn-on energy per pulse vs. on-state current and turn-on voltage.

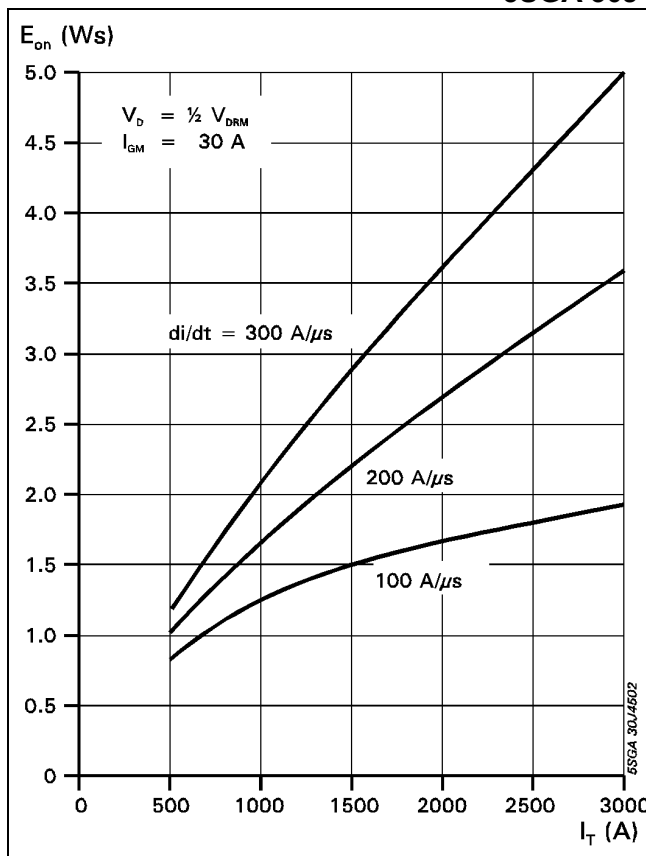

Fig. 10 Turn-on energy per pulse vs. on-state current and current rise rate

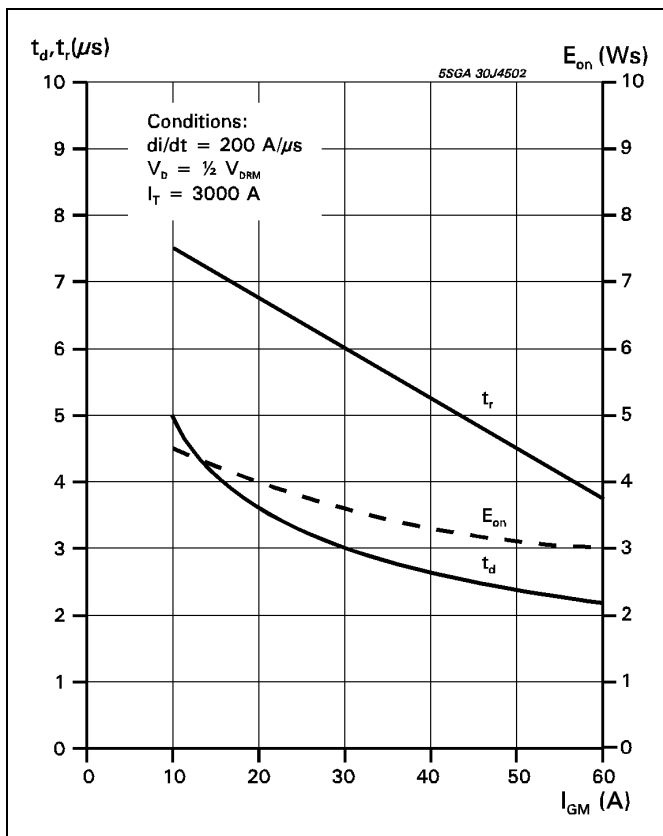

Fig. 11 Turn-on energy per pulse vs. on-state current and turn-on voltage.

Common Test conditions for figures 9, 10 and 11:

- $di_G/dt = 20 \text{ A}/\mu\text{s}$
- $C_S = 6 \mu\text{F}$
- $R_S = 5 \Omega$
- $T_j = 125 \text{ }^\circ\text{C}$

Definition of Turn-on energy:

$$E_{on} = \int_0^{20 \mu\text{s}} V_D \cdot I_T dt \quad (t = 0, I_G = 0.1 \cdot I_{GM})$$

Common Test conditions for figures 12, 13 and 15:

Definition of Turn-off energy:

$$E_{off} = \int_0^{40 \mu\text{s}} V_D \cdot I_T dt \quad (t = 0, I_T = 0.9 \cdot I_{TGO})$$

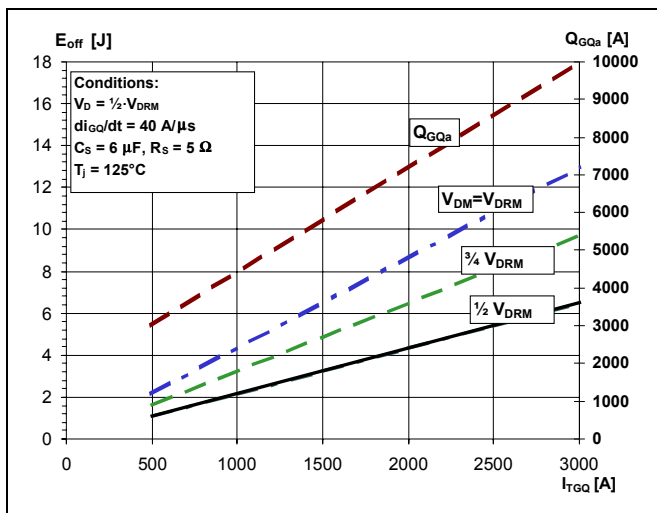

**Fig. 12** Turn-off energy per pulse vs. turn-off current and peak turn-off voltage. Extracted gate charge vs. turn-off current.

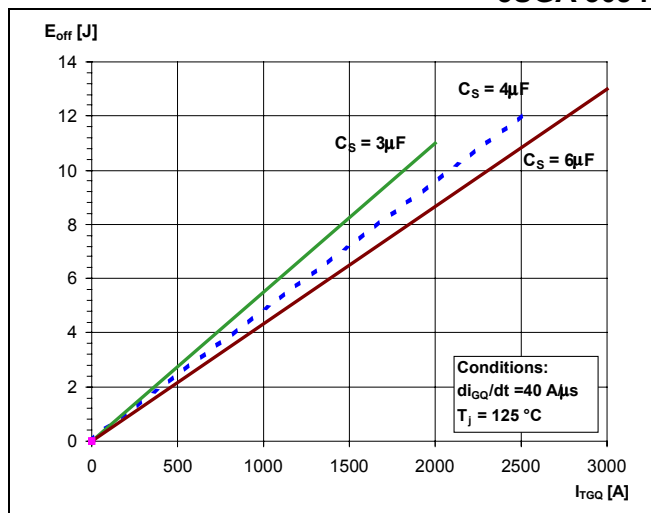

**Fig. 13** Turn-off energy per pulse vs. turn-off current and snubber capacitance.

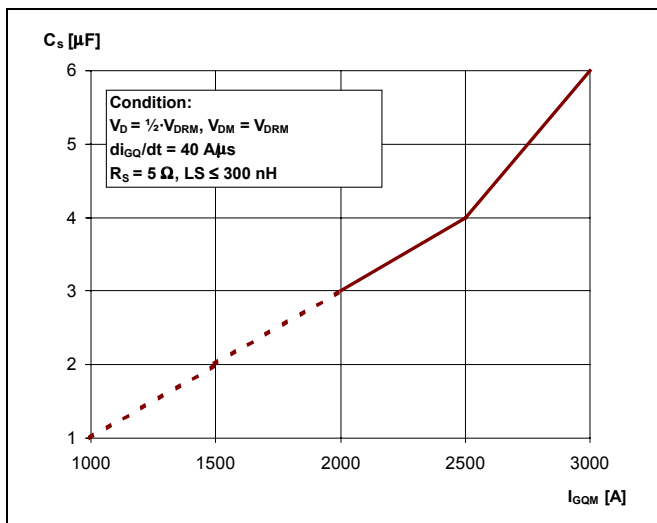

**Fig. 14** Required snubber capacitor vs. max allowable turn-off current.

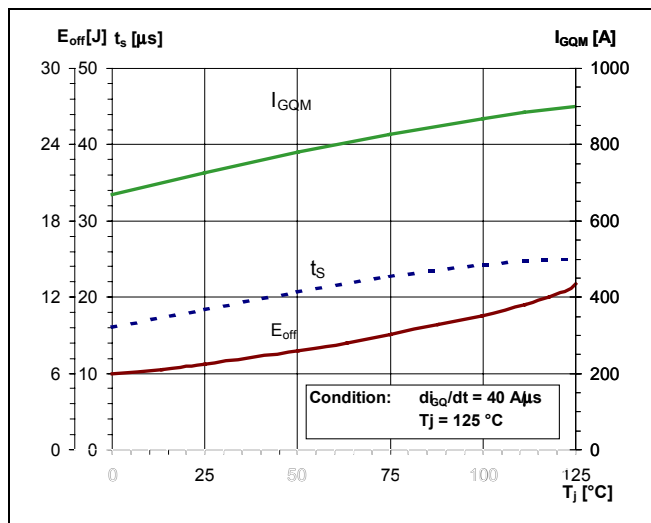

**Fig. 15** Turn-off energy per pulse, storage time and peak turn-off gate current vs. junction temperature.

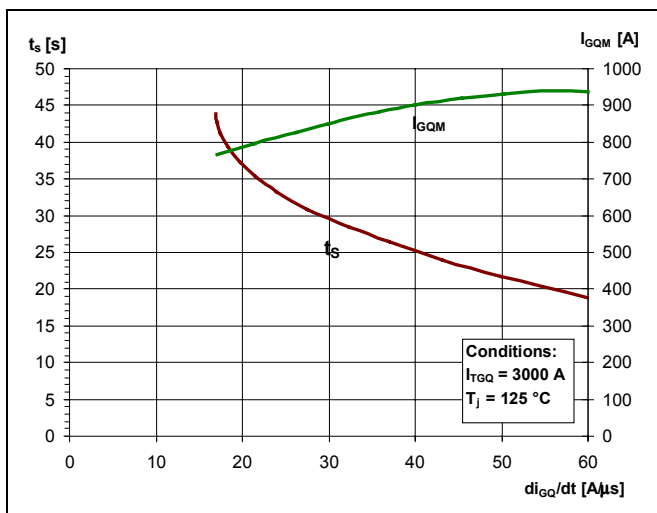

**Fig. 16** Storage time and peak turn-off gate current vs. neg. gate current rise rate.

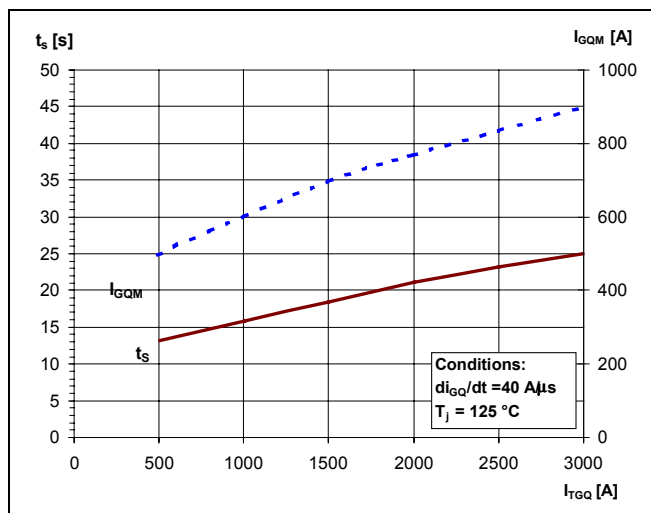

**Fig. 17** Storage time and peak turn-off gate current vs. turn-off current.

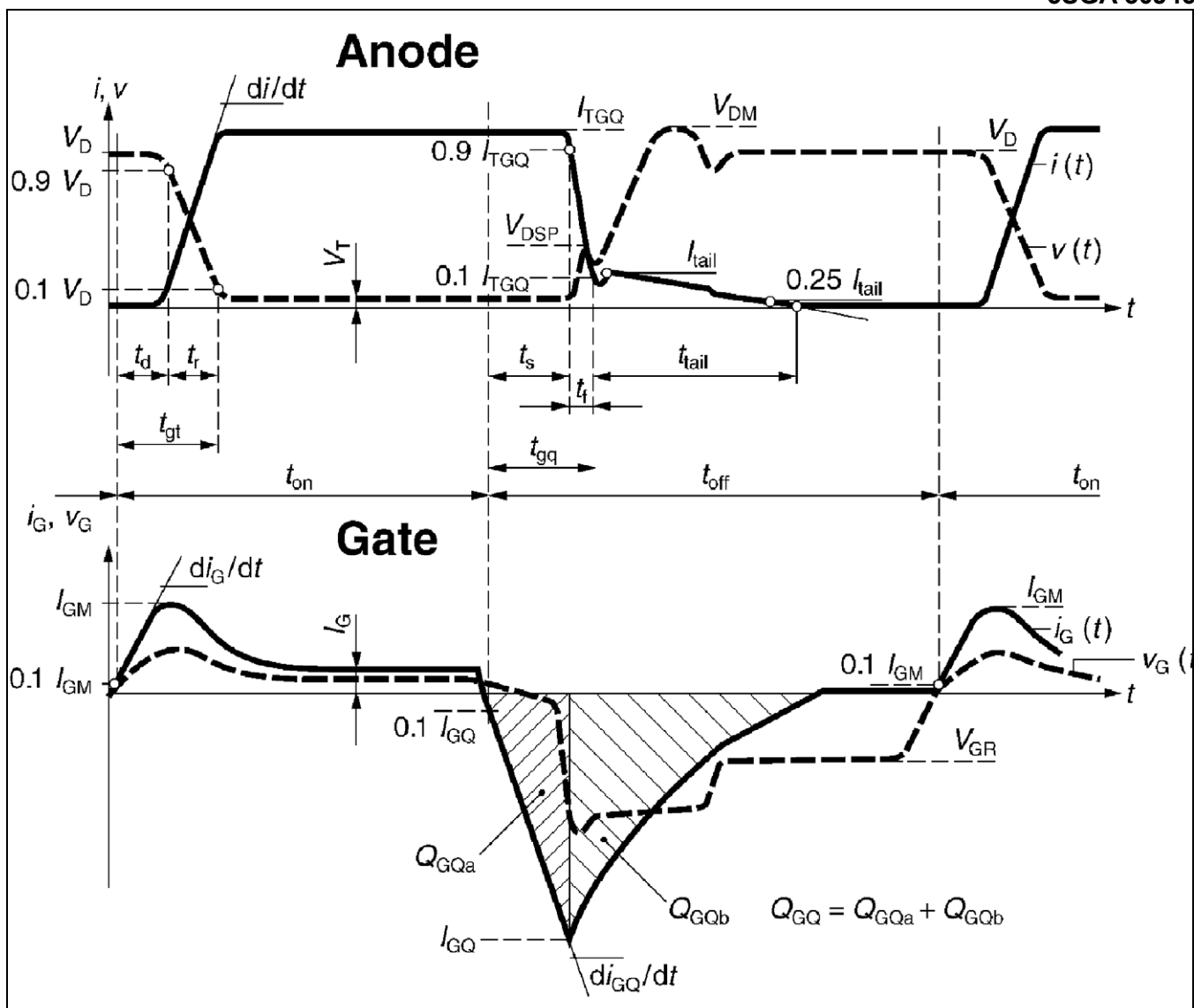

Fig. 18 General current and voltage waveforms with GTO-specific symbols.

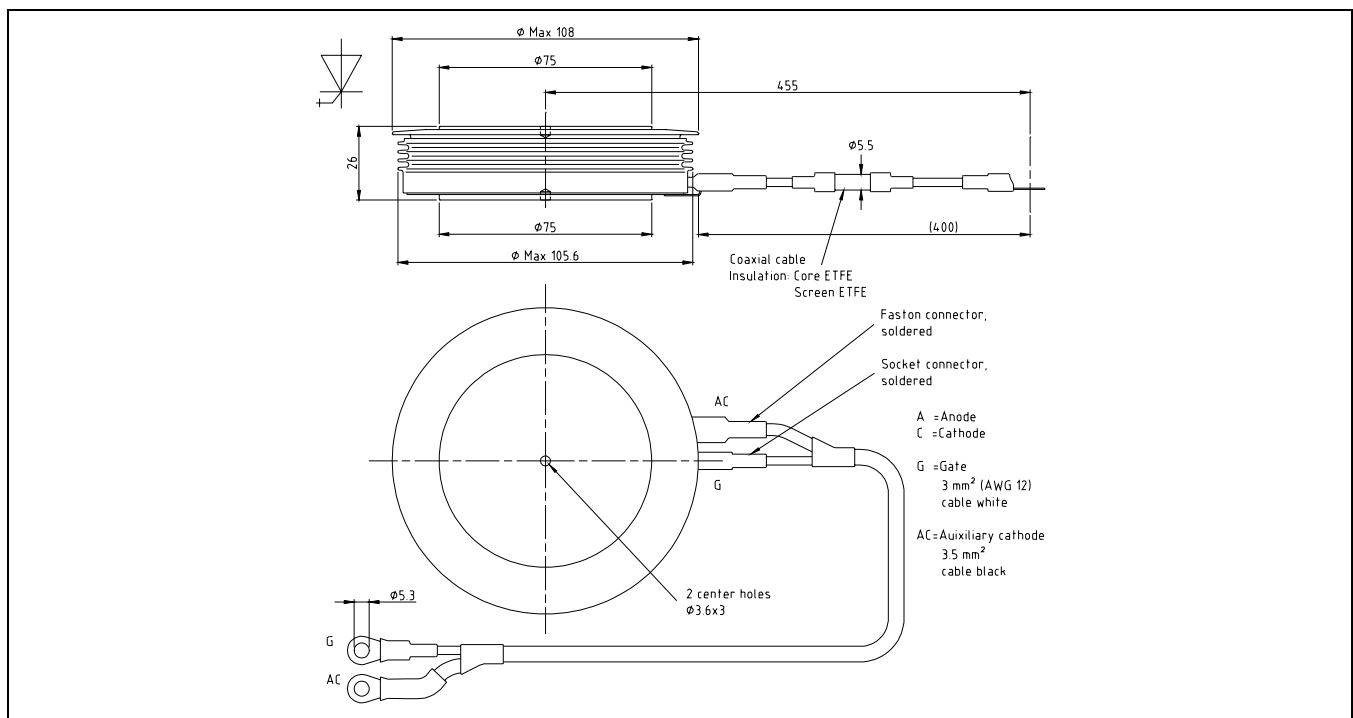

Fig. 19 Outline drawing. All dimensions are in millimeters and represent nominal values unless stated otherwise.



**Reverse avalanche capability**

In operation with an antiparallel freewheeling diode, the GTO reverse voltage  $V_R$  may exceed the rate value  $V_{RRM}$  due to stray inductance and diode turn-on voltage spike at high  $di/dt$ . The GTO is then driven into reverse avalanche. This condition is not dangerous for the GTO provided avalanche time and current are below 10  $\mu s$  and 1000 A respectively. However, gate voltage must remain negative during this time. Recommendation :  $V_{GR} = 10... 15 V$ .

**Darrah Electric Company**  
5914 Merrill Avenue  
Cleveland, Ohio 44102 USA  
216-631-0912  
216-631-0440 fax  
[www.darrahelectric.com](http://www.darrahelectric.com)



ABB Switzerland Ltd, Semiconductors reserves the right to change specifications without notice.



**ABB Switzerland Ltd**  
**Semiconductors**  
Fabrikstrasse 3  
CH-5600 Lenzburg, Switzerland

Telephone +41 (0)58 586 1419  
Fax +41 (0)58 586 1306  
Email [abbsem@ch.abb.com](mailto:abbsem@ch.abb.com)  
Internet [www.abb.com/semiconductors](http://www.abb.com/semiconductors)

Doc. No. 5SYA1202-03 Jan. 03