

$V_{\text{DRM}} = 2500 \text{ V}$   
 $I_{\text{TGQM}} = 2000 \text{ A}$   
 $I_{\text{TSM}} = 16 \text{ kA}$   
 $V_{\text{T0}} = 1.66 \text{ V}$   
 $r_{\text{T}} = 0.57 \text{ m}\Omega$   
 $V_{\text{DClin}} = 1400 \text{ V}$

# Gate turn-off Thyristor

## 5SGA 20H2501

Doc. No. 5SYA1205-01 Jun. 04

- Patented free-floating silicon technology
- Low on-state and switching losses
- Annular gate electrode
- Industry standard housing
- Cosmic radiation withstand rating

**Authorized Distributor:**  
**Darrah Electric Company**  
**[www.darrahelectric.com](http://www.darrahelectric.com)**

### Blocking

$V_{\text{DRM}}$	Repetitive peak off-state voltage	2500 V	$V_{\text{GR}} \geq 2\text{V}$
$V_{\text{RRM}}$	Repetitive peak reverse voltage	17 V	
$I_{\text{DRM}}$	Repetitive peak off-state current	$\leq 30 \text{ mA}$	$V_{\text{D}} = V_{\text{DRM}} \quad V_{\text{GR}} \geq 2\text{V}$
$I_{\text{RRM}}$	Repetitive peak reverse current	$\leq 50 \text{ mA}$	$V_{\text{R}} = V_{\text{RRM}} \quad R_{\text{GK}} = \infty$
$V_{\text{DClink}}$	Permanent DC voltage for 100 FIT failure rate	1400 V	$-40 \leq T_{\text{j}} \leq 125 \text{ }^\circ\text{C}$ . Ambient cosmic radiation at sea level in open air.

### Mechanical data (see Fig. 19)

$F_{\text{m}}$	Mounting force	min.	17	kN
		max.	24	kN
A	Acceleration: Device unclamped Device clamped		50	$\text{m/s}^2$
			200	$\text{m/s}^2$
M	Weight		0.8	kg
$D_{\text{S}}$	Surface creepage distance	$\geq$	22	mm
$D_{\text{a}}$	Air strike distance	$\geq$	13	mm

**Darrah Electric Company**  
**5914 Merrill Avenue**  
**Cleveland, Ohio 44102 USA**  
**216-631-0912**  
**216-631-0440 fax**  
**[www.darrahelectric.com](http://www.darrahelectric.com)**



ABB Semiconductors AG reserves the right to change specifications without notice.

# ABB

**GTO Data****On-state**

$I_{TAVM}$	Max. average on-state current	830 A	Half sine wave, $T_C = 85\text{ }^\circ\text{C}$	
$I_{TRMS}$	Max. RMS on-state current	1300 A		
$I_{TSM}$	Max. peak non-repetitive surge current	16 kA	$t_P = 10\text{ ms}$	$T_j = 125\text{ }^\circ\text{C}$ After surge: $V_D = V_R = 0V$
		32 kA	$t_P = 1\text{ ms}$	
$I^2t$	Limiting load integral	$1.28 \cdot 10^6\text{ A}^2\text{s}$	$t_P = 10\text{ ms}$	
		$0.51 \cdot 10^6\text{ A}^2\text{s}$	$t_P = 1\text{ ms}$	
$V_T$	On-state voltage	2.80 V	$I_T = 2000\text{ A}$	$T_j = 125\text{ }^\circ\text{C}$
$V_{T0}$	Threshold voltage	1.66 V	$I_T = 200 - 2500\text{ A}$	
$r_T$	Slope resistance	0.57 m $\Omega$		
$I_H$	Holding current	50 A	$T_j = 25\text{ }^\circ\text{C}$	

**Gate**

$V_{GT}$	Gate trigger voltage	1.0 V	$V_D = 24\text{ V}$	$T_j = 25\text{ }^\circ\text{C}$
$I_{GT}$	Gate trigger current	2.5 A	$R_A = 0.1\text{ }\Omega$	
$V_{GRM}$	Repetitive peak reverse voltage	17 V		
$I_{GRM}$	Repetitive peak reverse current	50 mA	$V_G = V_{GRM}$	

**Turn-on switching**

$di/dt_{crit}$	Max. rate of rise of on-state current	400 A/ $\mu\text{s}$	$f = 200\text{ Hz}$	$I_T = 2000\text{ A}, T_j = 125\text{ }^\circ\text{C}$ $I_{GM} = 30\text{ A}, di_G/dt = 20\text{ A}/\mu\text{s}$
		700 A/ $\mu\text{s}$	$f = 1\text{ Hz}$	
$t_d$	Delay time	1.5 $\mu\text{s}$	$V_D = 0.5 V_{DRM}$	$T_j = 125\text{ }^\circ\text{C}$
$t_r$	Rise time	3.5 $\mu\text{s}$	$I_T = 2000\text{ A}$	$di/dt = 200\text{ A}/\mu\text{s}$
$t_{on(min)}$	Min. on-time	80 $\mu\text{s}$	$I_{GM} = 30\text{ A}$	$di_G/dt = 20\text{ A}/\mu\text{s}$
$E_{on}$	Turn-on energy per pulse	0.75 Ws	$C_S = 4\text{ }\mu\text{F}$	$R_S = 5\text{ }\Omega$

**Turn-off switching**

$I_{TGQM}$	Max controllable turn-off current	2000 A	$V_{DM} = V_{DRM}$	$di_{GQ}/dt = 30\text{ A}/\mu\text{s}$
			$C_S = 4\text{ }\mu\text{F}$	$L_S \leq 0.3\text{ }\mu\text{H}$
$t_s$	Storage time	22.0 $\mu\text{s}$	$V_D = \frac{1}{2} V_{DRM}$	$V_{DM} = V_{DRM}$
$t_f$	Fall time	2.0 $\mu\text{s}$	$T_j = 125\text{ }^\circ\text{C}$	$di_{GQ}/dt = 30\text{ A}/\mu\text{s}$
$t_{off(min)}$	Min. off-time	80 $\mu\text{s}$	$I_{TGQ} = I_{TGQM}$	
$E_{off}$	Turn-off energy per pulse	3.5 Ws	$C_S = 4\text{ }\mu\text{F}$	$R_S = 5\text{ }\Omega$
$I_{GQM}$	Peak turn-off gate current	700 A	$L_S \leq 0.3\text{ }\mu\text{H}$	

**Thermal**

$T_j$	Storage and operating junction temperature range	-40...125°C	
$R_{thJC}$	Thermal resistance junction to case	30 K/kW	Anode side cooled
		39 K/kW	Cathode side cooled
		17 K/kW	Double side cooled
$R_{thCH}$	Thermal resistance case to heat sink	10 K/kW	Single side cooled
		5 K/kW	Double side cooled

**Analytical function for transient thermal impedance:**

$$Z_{thJC}(t) = \sum_{i=1}^4 R_i (1 - e^{-t/\tau_i})$$

i	1	2	3	4
$R_i$ (K/kW)	11.7	4.7	0.64	0.0001
$\tau_i$ (s)	0.9	0.26	0.002	0.001

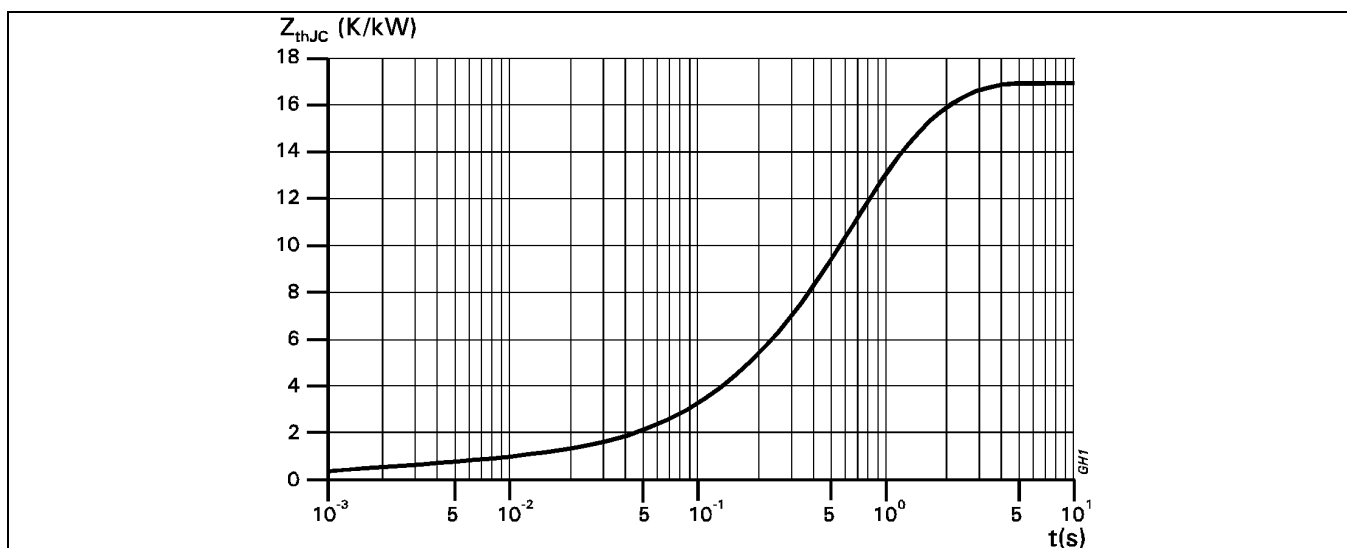

**Fig. 1** Transient thermal impedance, junction to case.

**Darrah Electric Company**  
 5914 Merrill Avenue  
 Cleveland, Ohio 44102 USA  
 216-631-0912  
 216-631-0440 fax  
[www.darrahelectric.com](http://www.darrahelectric.com)



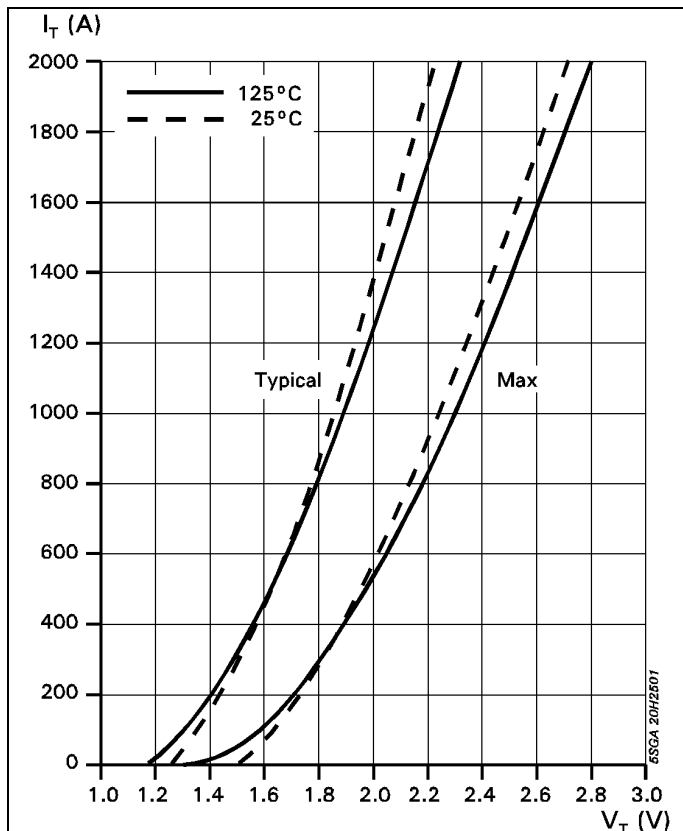

Fig. 2 On-state characteristics

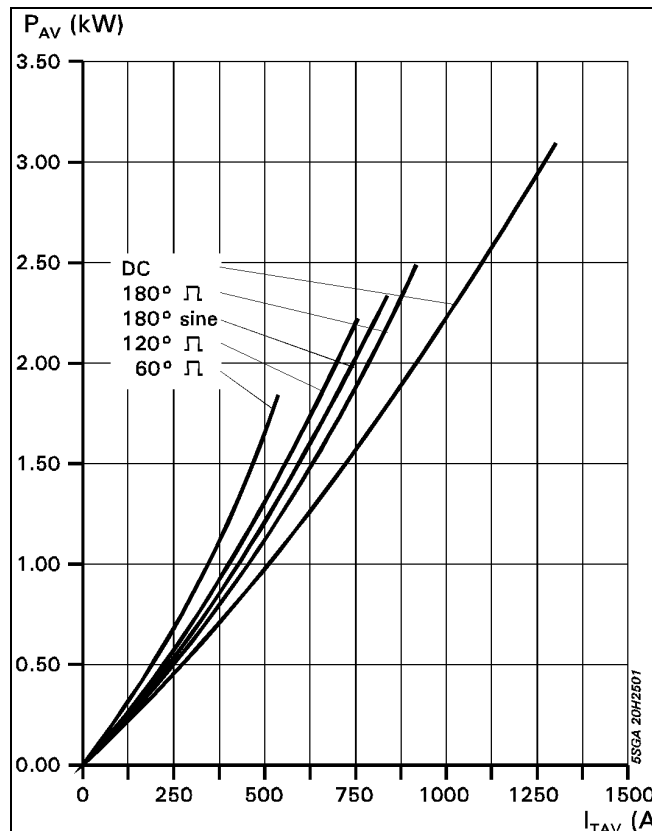

Fig. 3 Average on-state power dissipation vs. average on-state current.

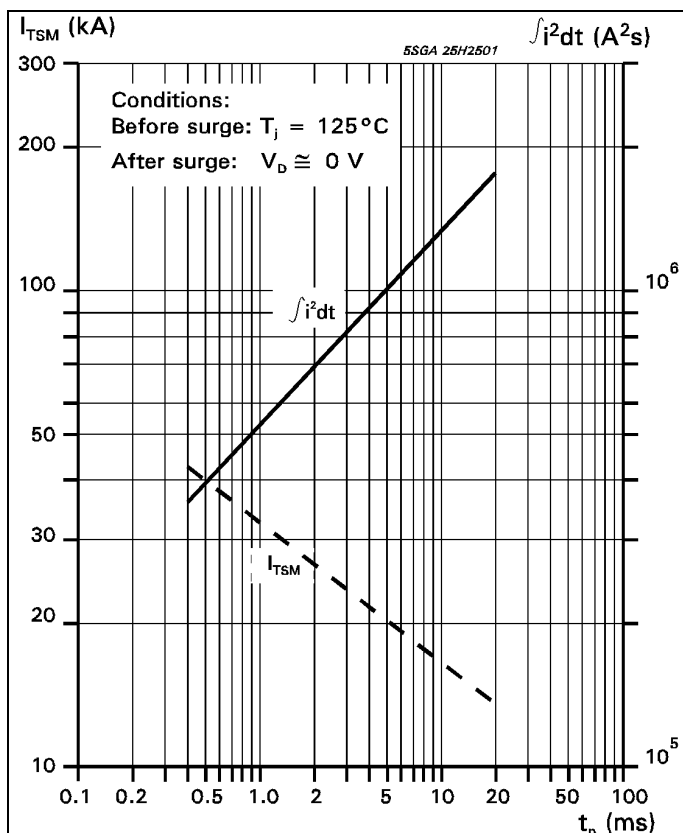
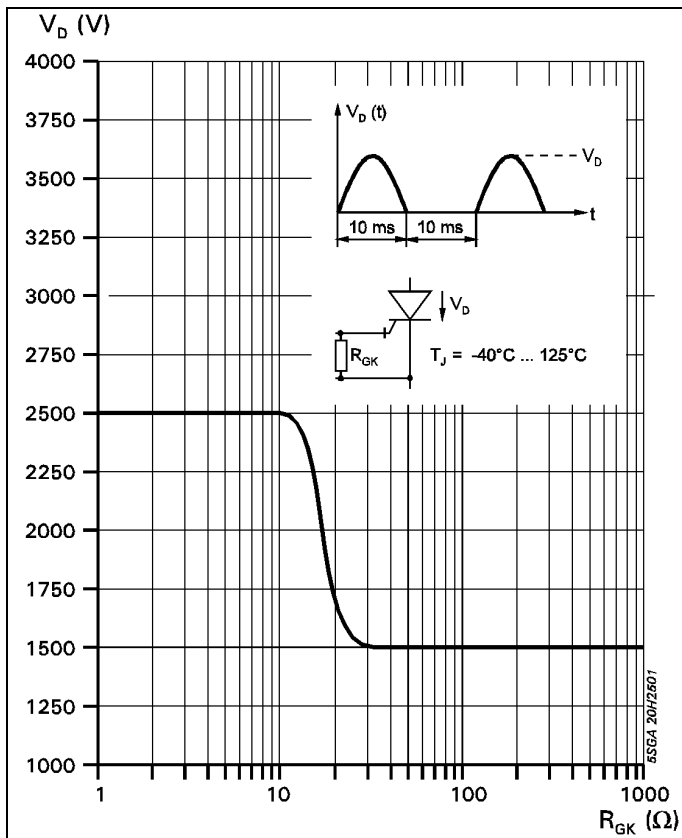
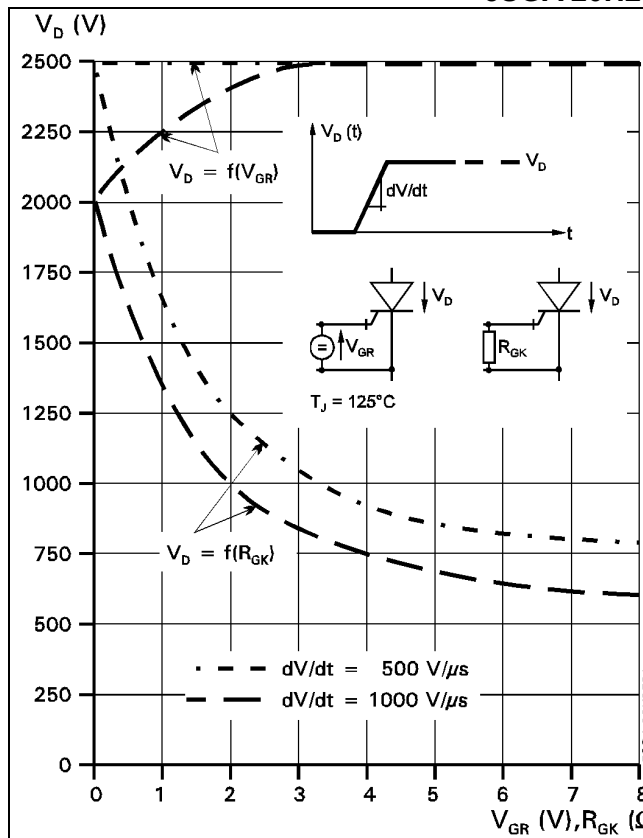

Fig. 4 Surge current and fusing integral vs. pulse width



**Fig. 5** Forward blocking voltage vs. gate-cathode resistance.



**Fig. 6** Static dv/dt capability: Forward blocking voltage vs. neg. gate voltage or gate cathode resistance.

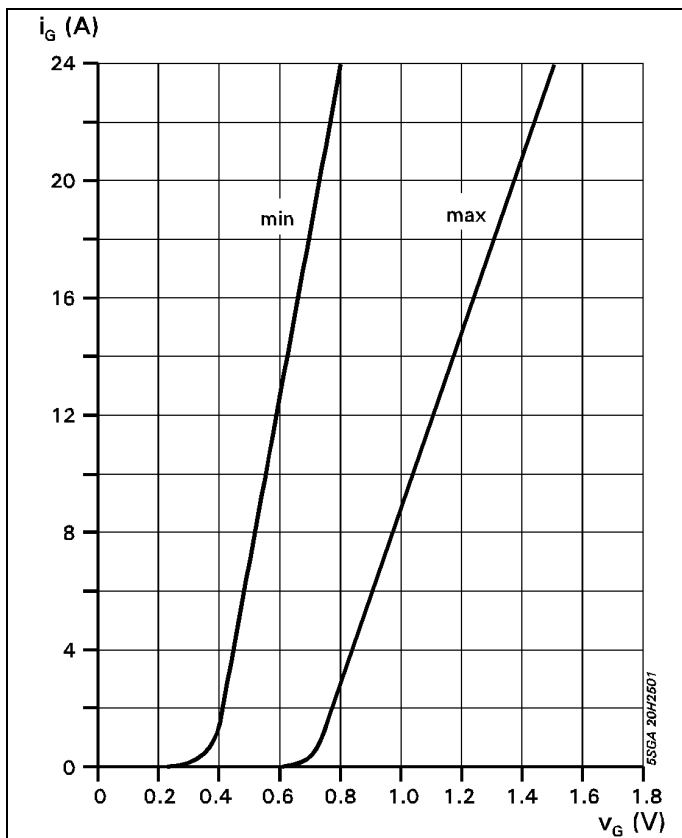

**Fig. 7** Forward gate current vs. forward gate voltage.

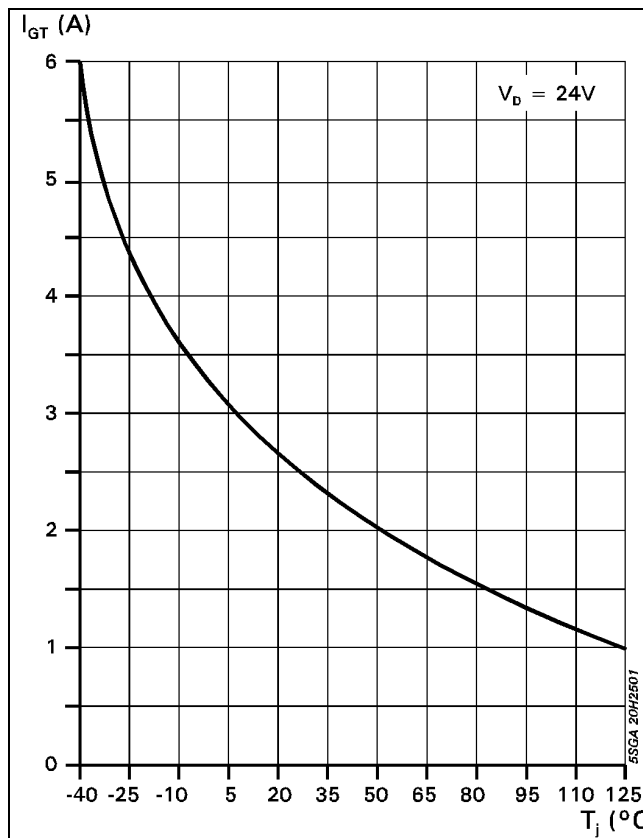

**Fig. 8** Gate trigger current vs. junction temperature

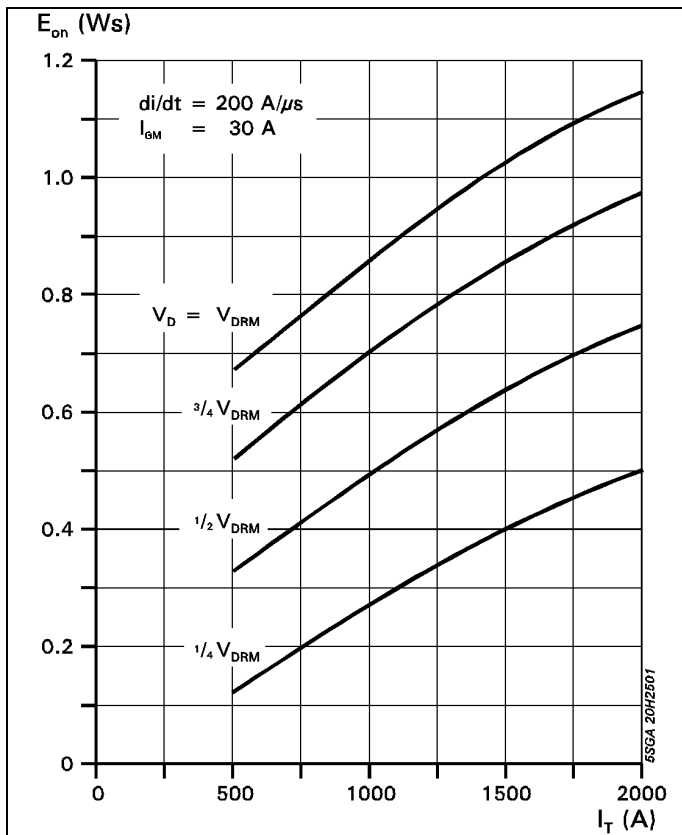

**Fig. 9** Turn-on energy per pulse vs. on-state current and turn-on voltage.

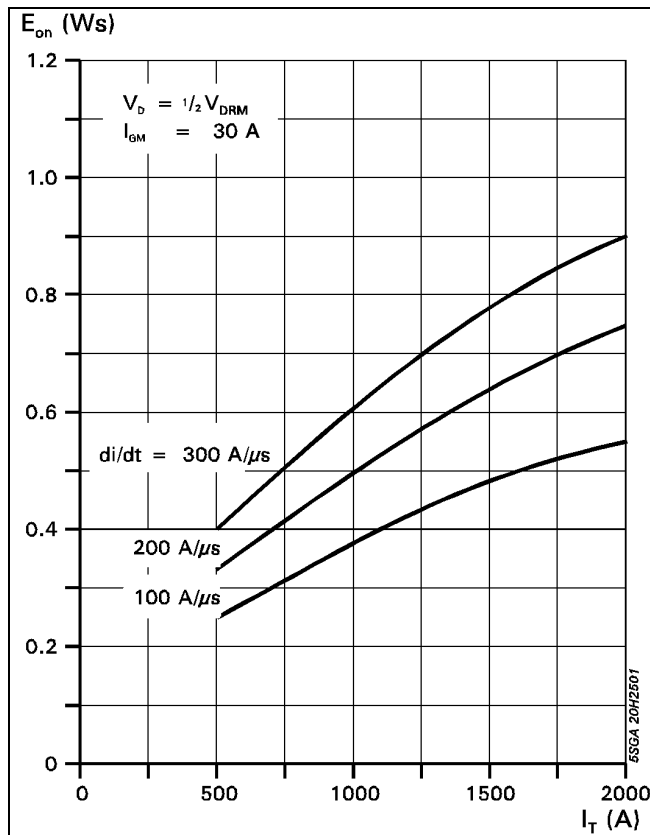

**Fig. 10** Turn-on energy per pulse vs. on-state current and current rise rate

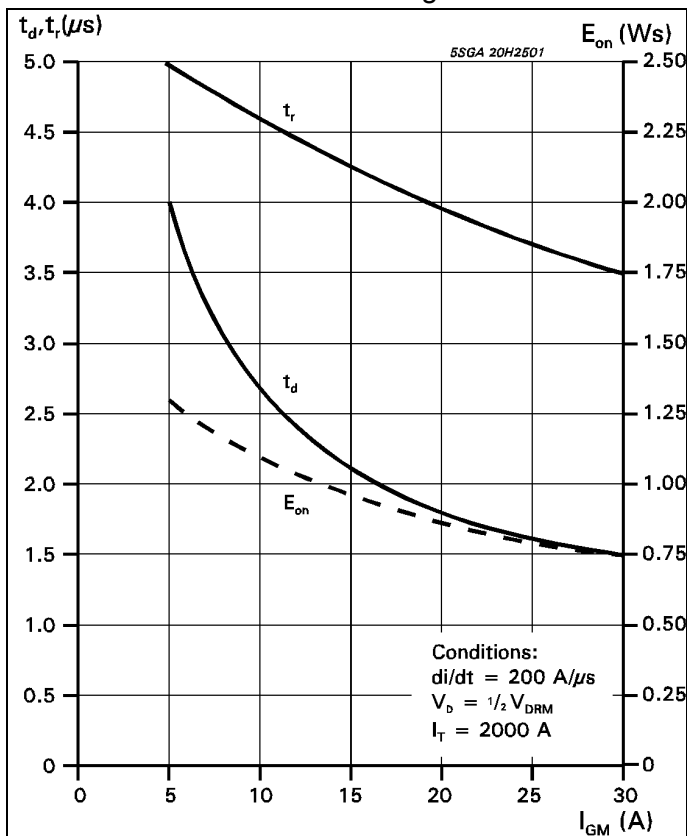

**Fig. 11** Turn-on energy per pulse vs. on-state current and turn-on voltage.

Common Test conditions for figures 9, 10 and 11:

- $di_G/dt = 20 \text{ A}/\mu\text{s}$
- $C_S = 4 \mu\text{F}$
- $R_S = 5 \Omega$
- $T_j = 125 \text{ }^\circ\text{C}$

Definition of Turn-on energy:

$$E_{on} = \int_0^{20 \mu\text{s}} V_D \cdot I_T dt \quad (t = 0, I_G = 0.1 \cdot I_{GM})$$

Common Test conditions for figures 12, 13 and 15:

Definition of Turn-off energy:

$$E_{off} = \int_0^{40 \mu\text{s}} V_D \cdot I_T dt \quad (t = 0, I_T = 0.9 \cdot I_{TGO})$$

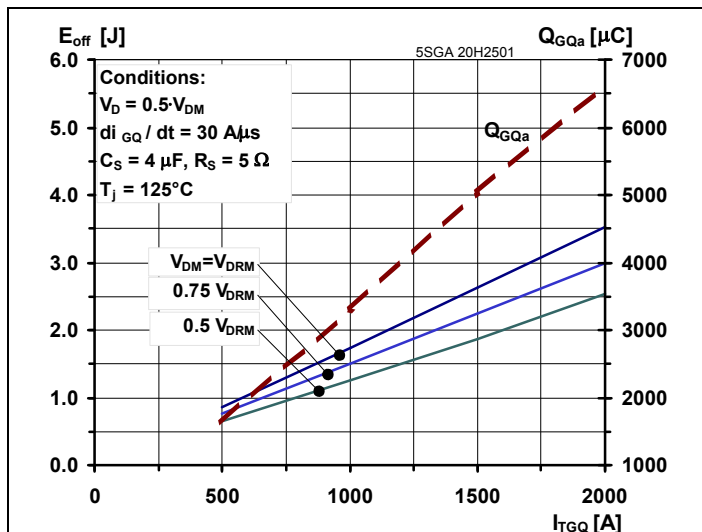

**Fig. 12** Turn-off energy per pulse vs. turn-off current and peak turn-off voltage. Extracted gate charge vs. turn-off current.

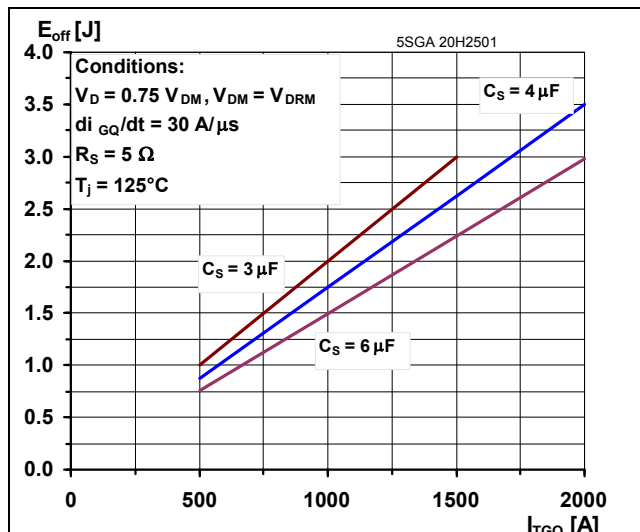

**Fig. 13** Turn-off energy per pulse vs. turn-off current and snubber capacitance.

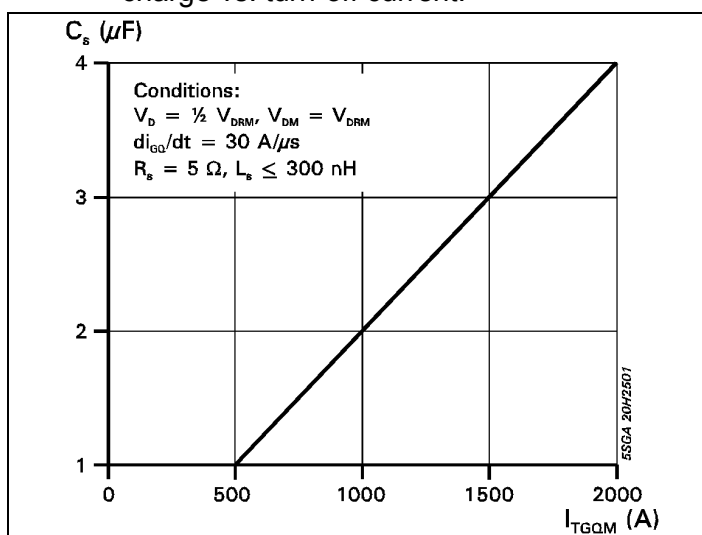

**Fig. 14** Required snubber capacitor vs. max allowable turn-off current.

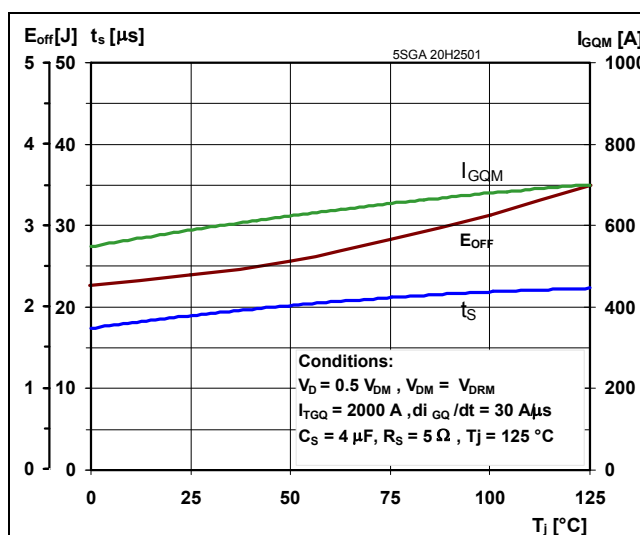

**Fig. 15** Turn-off energy per pulse, storage time and peak turn-off gate current vs. junction temperature

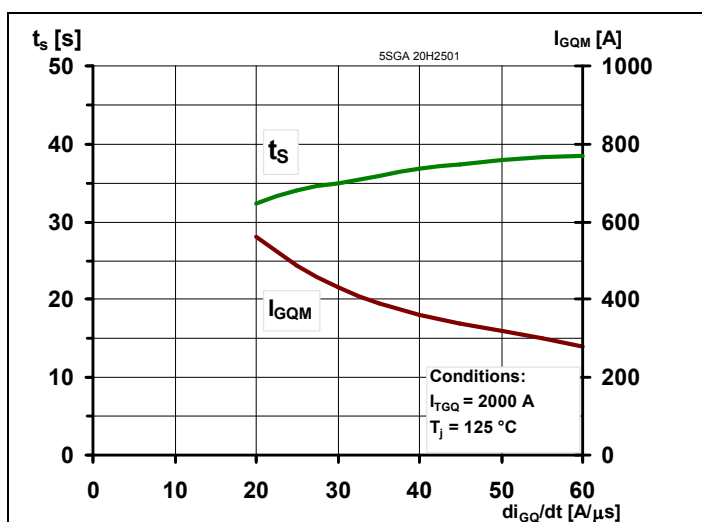

**Fig. 16** Storage time and peak turn-off gate current vs. neg. gate current rise rate.

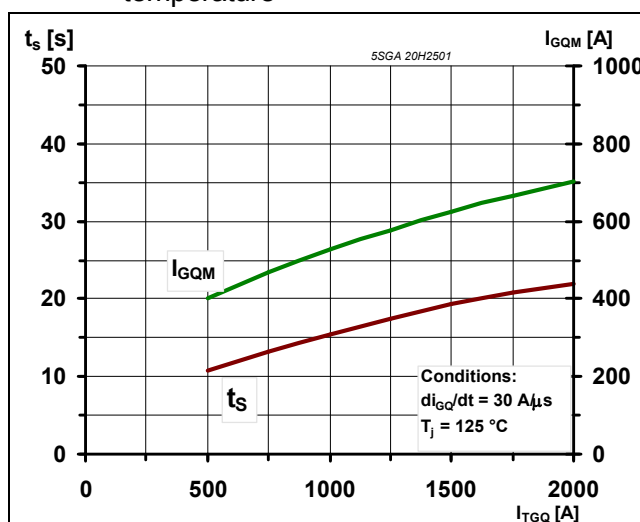

**Fig. 17** Storage time and peak turn-off gate current vs. turn-off current

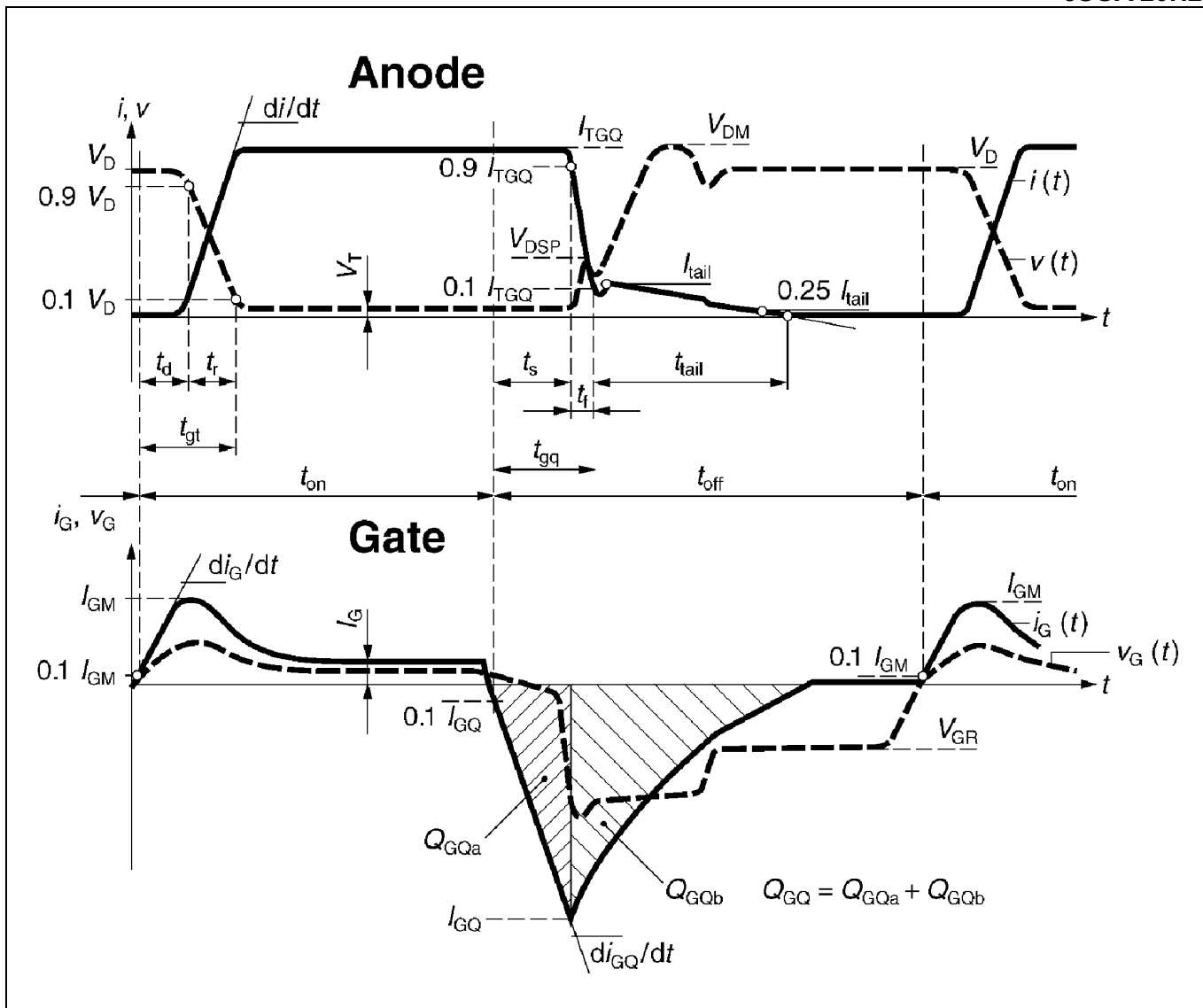

Fig. 18 General current and voltage waveforms with GTO-specific symbols

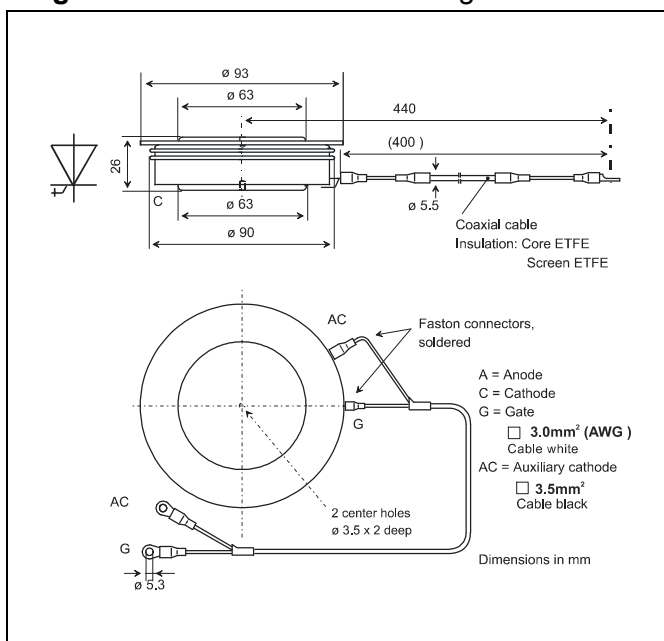

Fig. 19 Outline drawing. All dimensions are in millimeters and represent nominal values unless stated otherwise.



**Reverse avalanche capability**

In operation with an antiparallel freewheeling diode, the GTO reverse voltage  $V_R$  may exceed the rate value  $V_{RRM}$  due to stray inductance and diode turn-on voltage spike at high  $di/dt$ . The GTO is then driven into reverse avalanche. This condition is not dangerous for the GTO provided avalanche time and current are below 10  $\mu$ s and 1000 A respectively. However, gate voltage must remain negative during this time. Recommendation :  $V_{GR} = 10... 15$  V.

**ABB Semiconductors AG reserves the right to change specifications without notice.**

**ABB Semiconductors AG**

Fabrikstrasse 3  
CH-5600 Lenzburg, Switzerland

Tel: +41 (0)62 888 6419  
Fax: +41 (0)62 888 6306  
E-mail [info@ch.abb.com](mailto:info@ch.abb.com)  
Internet [www.abbsem.com](http://www.abbsem.com)