

$V_{RRM}$	=	5000 V
$I_{F(AV)M}$	=	3810 A
$I_{F(RMS)}$	=	5990 A
$I_{FSM}$	=	$45 \times 10^3$ A
$V_{F0}$	=	0.903 V
$r_F$	=	0.136 mW

# Rectifier Diode

## 5SDD 38H5000

Doc. No. 5SYA1177-00 Sept. 07

- Optimum power handling capability
- Very low on-state losses

**Authorized Distributor:**  
**Darrah Electric Company**  
**[www.darrahelectric.com](http://www.darrahelectric.com)**

### Blocking

#### Maximum rated values <sup>Note 1</sup>

Parameter	Symbol	Conditions	Value	Unit
Repetitive peak reverse voltage	$V_{RRM}$	$f = 50$ Hz, $t_p = 10$ ms, $T_j = -40 \dots 160$ °C	5000	V

#### Characteristic values

Parameter	Symbol	Conditions	min	typ	max	Unit
Max. (reverse) leakage current	$I_{RRM}$	$V_{RRM}$ , $T_j = 160$ °C			110	mA

Derating factor of 0.13% per °C is applicable for  $T_j$  below 0 °C.

### Mechanical data

#### Maximum rated values <sup>Note 1</sup>

Parameter	Symbol	Conditions	min	typ	max	Unit
Mounting force	$F_M$		45	50	55	kN
Acceleration	a	Device unclamped			50	$m/s^2$
Acceleration	a	Device clamped			100	$m/s^2$

#### Characteristic values

Parameter	Symbol	Conditions	min	typ	max	Unit
Weight	m			0.9		kg
Housing thickness	H	$F_M = 50$ kN, $T_a = 25$ °C	25.5		26.5	mm
Surface creepage distance	$D_S$		40			mm
Air strike distance	$D_a$		20			mm

Note 1 Maximum rated values indicate limits beyond which damage to the device may occur

ABB Switzerland Ltd, Semiconductors reserves the right to change specifications without notice.



## On-state

### Maximum rated values Note 1

Parameter	Symbol	Conditions	min	typ	max	Unit
Max. average on-state current	$I_{F(AV)M}$	50 Hz, Half sine wave, $T_C = 85^\circ\text{C}$			3810	A
Max. RMS on-state current	$I_{F(RMS)}$				5990	A
Max. peak non-repetitive surge current	$I_{FSM}$	$t_p = 10\text{ ms}$ , $T_j = 160^\circ\text{C}$ , $V_R = 0\text{ V}$			$45 \times 10^3$	A
Limiting load integral	$I^2t$				$10.1 \times 10^6$	$\text{A}^2\text{s}$
Max. peak non-repetitive surge current	$I_{FSM}$	$t_p = 8.3\text{ ms}$ , $T_j = 160^\circ\text{C}$ , $V_R = 0\text{ V}$			$48 \times 10^3$	A
Limiting load integral	$I^2t$				$9.6 \times 10^6$	$\text{A}^2\text{s}$

### Characteristic values

Parameter	Symbol	Conditions	min	typ	max	Unit
On-state voltage	$V_F$	$I_F = 4000\text{ A}$ , $T_j = 160^\circ\text{C}$			1.43	V
Threshold voltage	$V_{(T0)}$	$T_j = 160^\circ\text{C}$			0.903	V
Slope resistance	$r_T$	$I_T = 6000 \dots 18000\text{ A}$			0.136	$\text{m}\Omega$

## Switching

### Characteristic values

Parameter	Symbol	Conditions	min	typ	max	Unit
Recovery charge	$Q_{rr}$	$di_F/dt = -30\text{ A}/\mu\text{s}$ , $V_R = 100\text{ V}$ $I_F = 2000\text{ A}$ , $T_j = 160^\circ\text{C}$		9000		$\mu\text{As}$

**Darrah Electric Company**  
**5914 Merrill Avenue**  
**Cleveland, Ohio 44102 USA**  
**216-631-0912**  
**216-631-0440 fax**  
**www.darrahelectric.com**



## Thermal

Maximum rated values <sup>1)</sup>

Parameter	Symbol	Conditions	min	typ	max	Unit
Operating junction temperature range	$T_{vj}$		-40		160	°C
Storage temperature range	$T_{stg}$		-40		160	°C

### Characteristic values

Parameter	Symbol	Conditions	min	typ	max	Unit
Thermal resistance junction to case	$R_{th(j-c)}$	Double-side cooled $F_m = 45...55$ kN			8	K/kW
	$R_{th(j-c)A}$	Anode-side cooled $F_m = 45...55$ kN			14.5	K/kW
	$R_{th(j-c)C}$	Cathode-side cooled $F_m = 45...55$ kN			18.0	K/kW
Thermal resistance case to heatsink	$R_{th(c-h)}$	Double-side cooled $F_m = 45...55$ kN			2.5	K/kW
	$R_{th(c-h)}$	Single-side cooled $F_m = 45...55$ kN			5.0	K/kW

Analytical function for transient thermal impedance:

$$Z_{th(j-c)}(t) = \sum_{i=1}^n R_{th i} (1 - e^{-t/\tau_i})$$

i	1	2	3	4
$R_{th i}$ (K/kW)	4.533	2.255	0.868	0.345
$\tau_i$ (s)	0.4406	0.1045	0.0092	0.0022

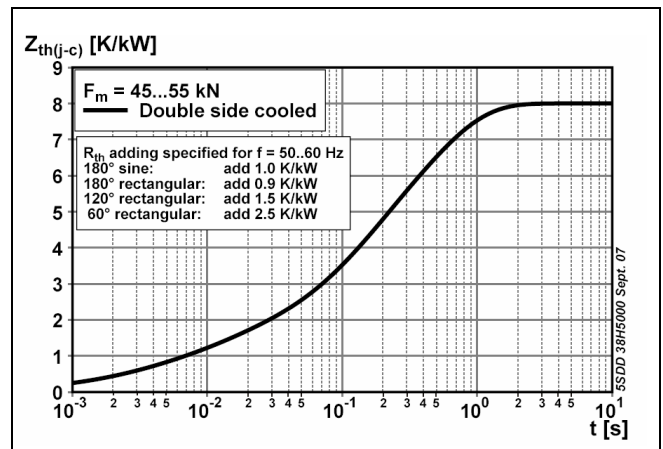

Fig. 1 Transient thermal impedance junction-to-case

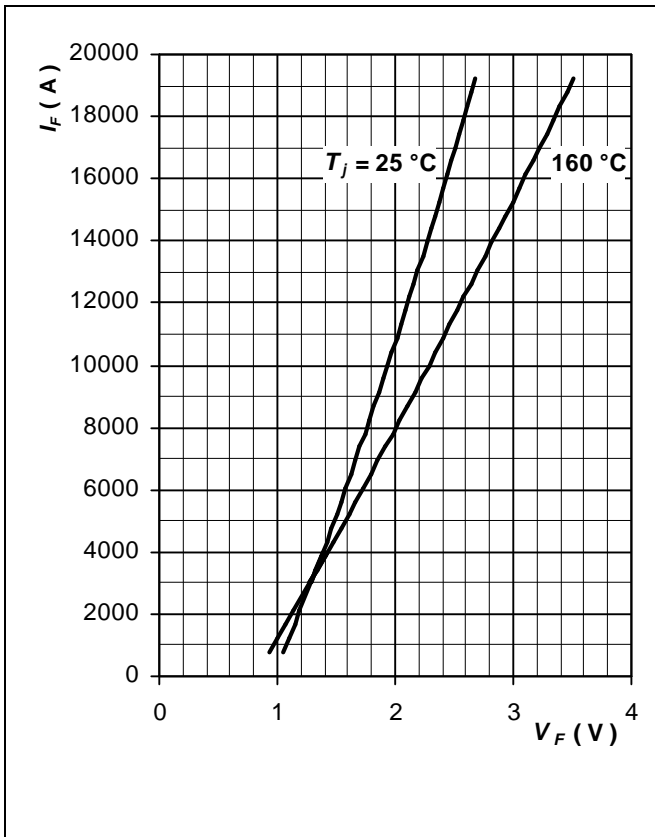

Fig. 2 Max. on-state characteristics

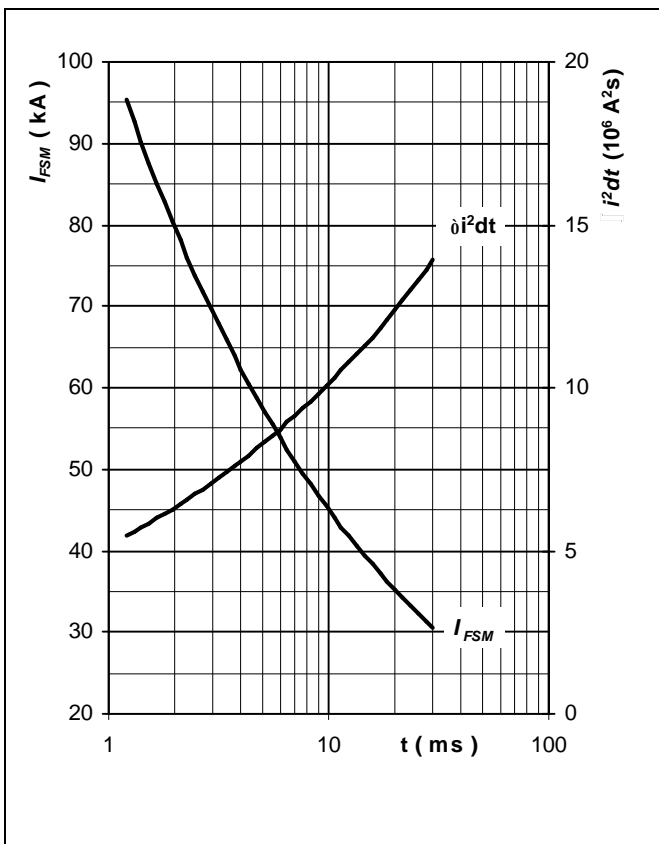

Fig. 3 Surge forward current vs. pulse length, half sine wave, single pulse,  $V_R = 0\text{ V}$

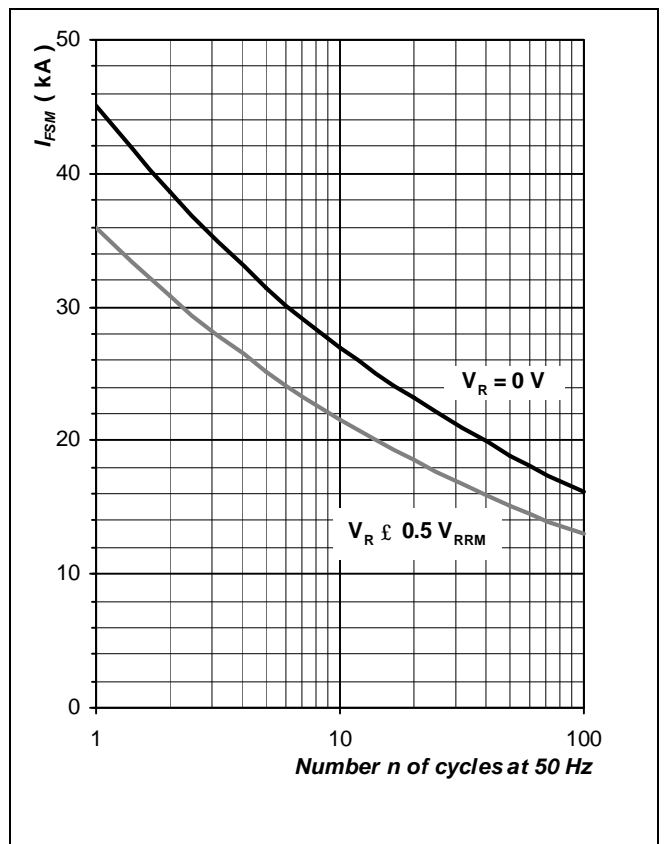
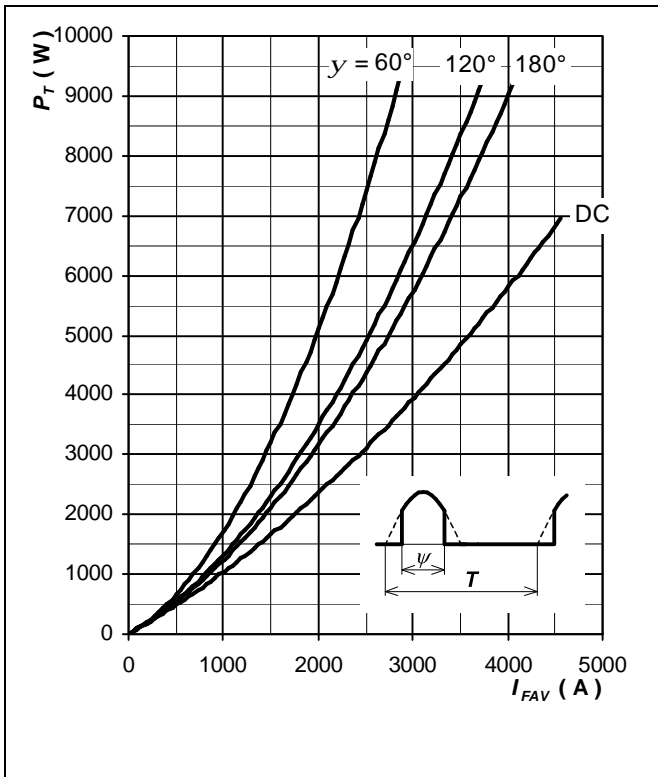
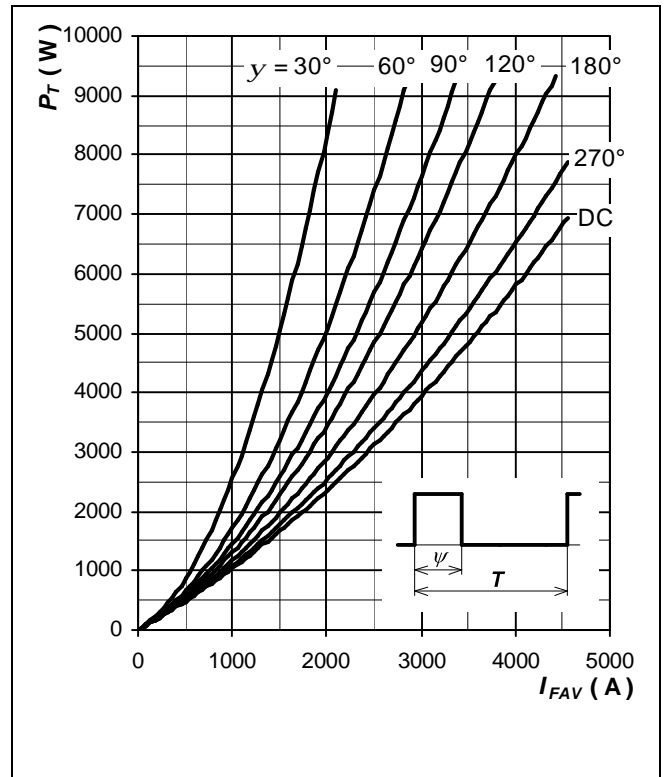

Fig. 4 Surge forward current vs. number of pulses, half sine wave



**Fig. 5** Forward power loss vs. average forward current, sine waveform,  $f = 50$  Hz



**Fig. 6** Forward power loss vs. average forward current, square waveform,  $f = 50$  Hz

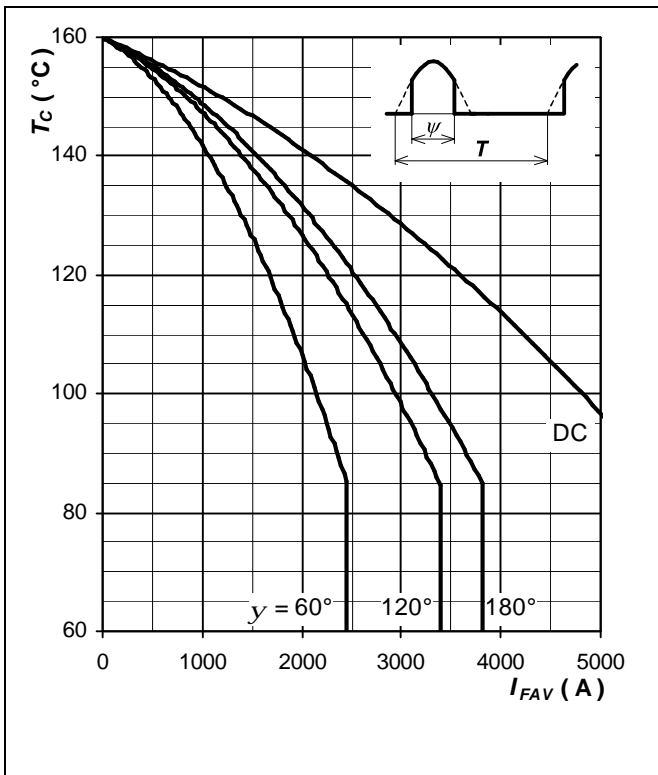

**Fig. 7** Max. case temperature vs. aver. forward current, sine waveform,  $f = 50$  Hz

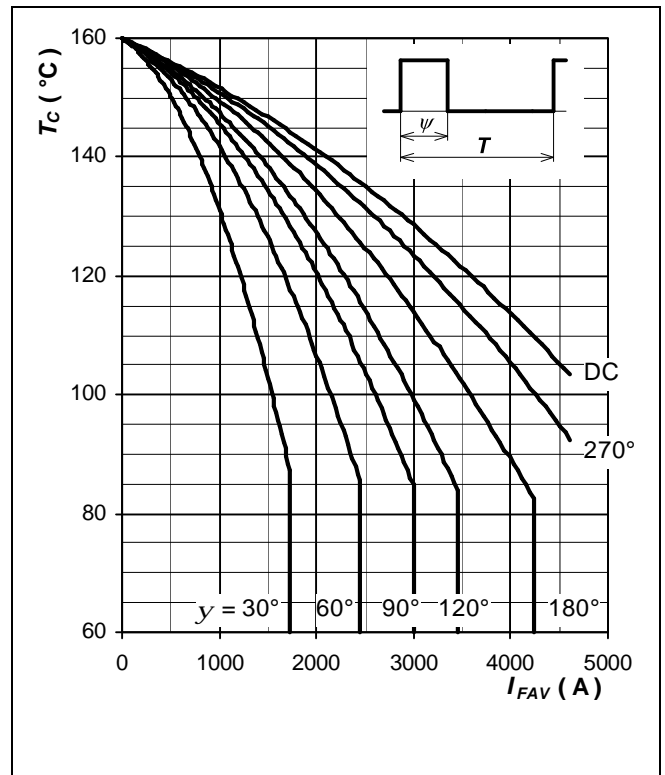

**Fig. 8** Max. case temperature vs. aver. forward current, square waveform,  $f = 50$  Hz

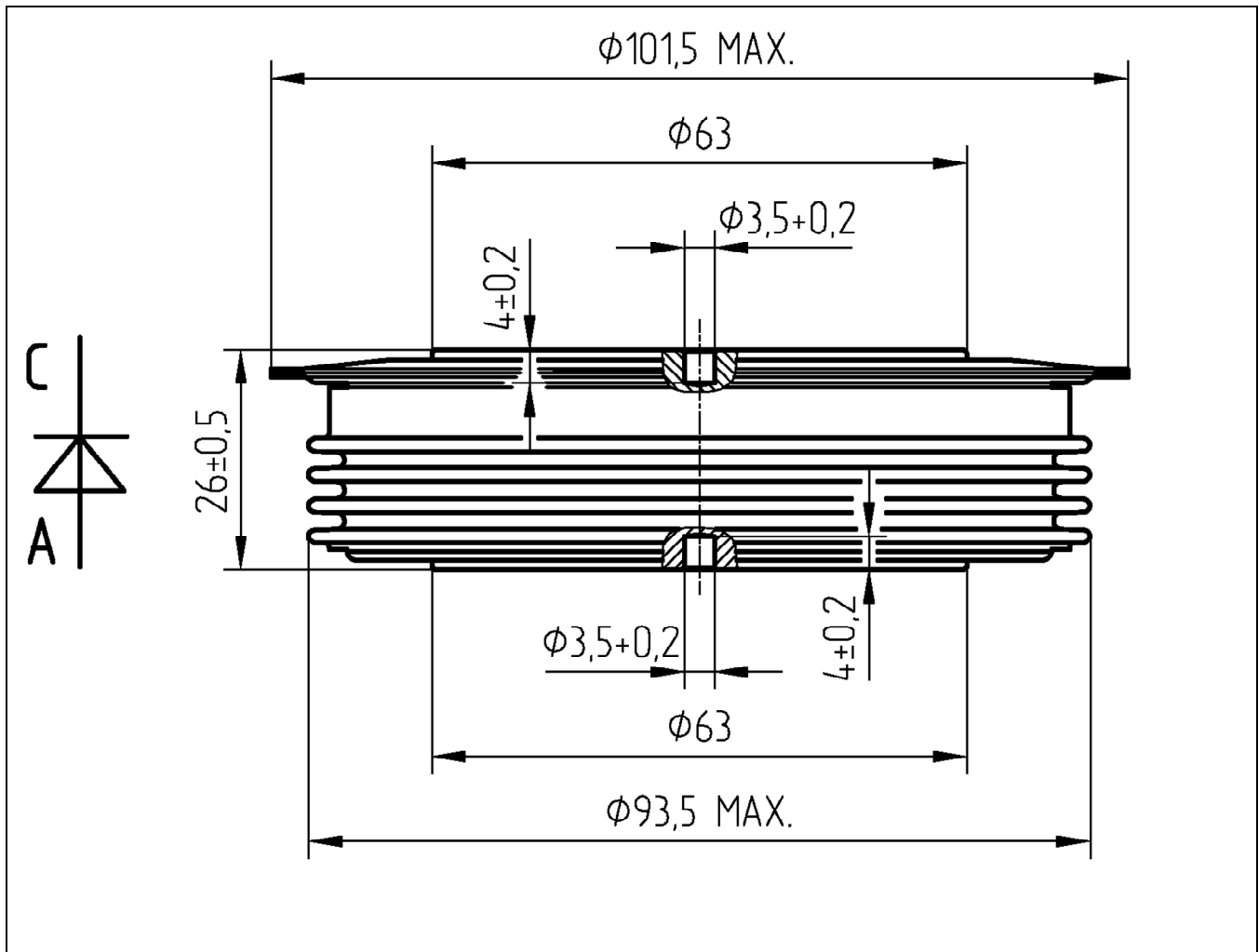

**Fig. 9** Outline drawing; all dimensions are in millimeters and represent nominal values unless stated otherwise

### Related documents:

5SYA 2020	Design of RC-Snubbers for Phase Control Applications
5SYA 2029	High Power Rectifier Diodes
5SYA 2036	Recommendations regarding mechanical clamping of Press Pack High Power Semiconductors
5SZK 9104	Specification of environmental class for pressure contact diodes, PCTs and GTO, STORAGE available on request, please contact factory
5SZK 9105	Specification of environmental class for pressure contact diodes, PCTs and GTO, TRANSPORTATION available on request, please contact factory

Please refer to <http://www.abb.com/semiconductors> for current version of documents.

**ABB Switzerland Ltd, Semiconductors reserves the right to change specifications without notice.**



**ABB Switzerland Ltd**  
**Semiconductors**  
 Fabrikstrasse 3  
 CH-5600 Lenzburg, Switzerland

Doc. No. 5SYA1177-00 Sept. 07

Telephone +41 (0)58 586 1419  
 Fax +41 (0)58 586 1306  
 Email [abbsem@ch.abb.com](mailto:abbsem@ch.abb.com)  
 Internet [www.abb.com/semiconductors](http://www.abb.com/semiconductors)